



ISSN: 1813-162X (Print) ; 2312-7589 (Online)

Tikrit Journal of Engineering Sciences

available online at: <http://www.tj-es.com>
**TJES**  
 Tikrit Journal of  
 Engineering Sciences

Ghanim Thiab Hasan <sup>1, \*</sup>  
 Muhamad Omar Salih <sup>2</sup>  
 Ali Hlal Mutlaq <sup>3</sup>

<sup>1</sup> Oil & Minerals Engineering College  
 Tikrit University  
 Salahaldeen  
 Iraq

<sup>2</sup> College of Engineering  
 Tikrit University  
 Salahaldeen  
 Iraq

<sup>3</sup> Technical College/ Kirkuk  
 Kirkuk  
 Iraq

Tikrit Journal of Engineering Sciences

## Study the Effect of Serial Inductance on Reducing the Current Harmonic Distortion of Three-Phase Bridge Rectifier

### ABSTRACT

The aim of this paper is to analyze the influence of adding serial inductance in AC side of the 3ph -6 pulse bridge rectifier on the reduction of harmonic distortion rate. A simulated model with serial inductance was analyzed. The 3-phase 6-pulse diode bridge rectifier was chosen because it corresponds to the operation of the 6-pulse thyristor bridge rectifier at maximum load (while keeping the angle  $\alpha = 0$ ). Both the total harmonic distortion (THDi) and the power factor (PF) for the circuit have been measured. The results obtained of the THDi has been recorded for four values of serial inductance and results was compared with the (IEEE 519-1992) standard. Comparison results indicates that for values of inductive reactance ( $X_i$ ) up to 67% cause a reduction of THDi which is above the standard values, while for ( $X_i$ ) more than 67% cause a reduction in THDi within the acceptable standard level. Analyzing of results prove that the adding of serial inductance at the AC side leads to good reduction in harmonic distortion rate, but with some reduction in power factor value, which results in some energy losses.

### Keywords:

Serial inductance  
 current harmonics distortion  
 bridge rectifier

### ARTICLE INFO

#### Article history:

Received 05 March 2017  
 Accepted 17 April 2018  
 Available online 01 September 2018

© 2018 TJES, College of Engineering, Tikrit University

DOI: <http://dx.doi.org/10.25130/tjes.25.3.01>

## دراسة تأثير الحث المتوالي على تقليل التشويه الحاصل في حزمة تيار معدل الموجة الكاملة ثلاثي

### الخلاصة

الهدف من هذه البحث هو تحليل تأثير إضافة المحاثة المتواليه في مدخل المقوم الجسري الثلاثي الطور على تقليل معدل التشويه التوافقي الحاصل في حزمة التيار المتردد باستخدام نموذج محاكاة لمقوم جسري ثلاثي الطور مكون من 6 دايودات لتوافقه مع شروط تشغيل المقوم الجسري المركب من 6 ثايرستورات (مع الحفاظ على السزواية  $\alpha = 0$ ). تم قياس كل من التشويه التوافقي الكلي (THDi) وعامل القدرة (PF) للدائرة لثلاث قيم مختلفة، حيث تم زيادة قيم المحاثة لثلاث مرات وتمت مقارنة النتائج مع المعيار (IEEE 519-1992) المسموح به لقيمة (THDi). نتائج المقارنة تشير إلى أن قيمة (THDi) تبقى فوق المستوى المسموح به لحد 67% من قيمة ممانعة الملف ( $X_i\%$ )، أما عند زيادة قيمة الـ ( $X_i\%$ ) لأكثر من ذلك سيحصل انخفاض في معدل الـ THDi بنسبة وهو ضمن المستوى القياسي المقبول. تحليل النتائج يشير إلى أن إضافة المحاثة المتواليه في مدخل المقوم الجسري الثلاثي الطور يؤدي إلى انخفاض جيد في معدل التشويه التوافقي مع بعض الخسائر في قيمة عامل القدرة.

### 1. INTRODUCTION

Advances in semiconductor fabrication technology have resulted in the development of the Variable Frequency induction motors drive (VFIMD), which are used in many applications such as air conditioning, fans, water treatment pumps, textile works, rolling mills etc. The more practical VFIMD method is direct torque control because it offers better performance than other control methods [1]. The Direct Torque drive technique is used in

the power source inverter, which is mainly powered by 6-pulse bridge diode rectifier, and insulated gate bipolar transistors (IGBT) [2]. The most common disadvantage of the Rectifier with a 6-pulse bridge diode is the small power factor of the current harmonics in the mains. Harmonic current of the power source causes harmonic polluted voltages at the common coupling point (PCC) and, therefore, unwanted voltage distortion will be created in the circuit loads [3]. The total harmonic distortion harmonic current values introduced into the supply system

\* Corresponding author: E-mail : [ganimdiab@yahoo.com](mailto:ganimdiab@yahoo.com)

by a non-linear load, such THD must be kept within the standard limits.

Many input wave-forming techniques have been suggested for reducing the total harmonic distortion level, which can be classified in both active and passive methods. The passive filter often used to eliminate the ripple content from the output, but they create a rectangular wave of input current that contains higher total harmonic distortion [4].

Harmonic distortions can cause many problems, including, equipment overheating, operating errors in protective relays, communications equipment malfunctions, etc. Harmonic frequencies represent the multiple of their fundamental frequency. When the harmonic level exceeds the limit, it is necessary to reduce it to ensure satisfactory operation of the system [5]. An interesting design that presented by M. Peterson and B. Singh which come to result that under reduced loading conditions, the firing angle increased, which led to higher THD and lower efficiency of the system [6]. Authors proposed a dynamic control scheme that involves simultaneous and selective control of firing angle and the pulse count of converter. For pulse count control, an appropriate 6-pulse rectifier or pair of 6-pulse rectifiers is disabled or enabled depending on the current loading. In their design D. C. Ku were tried to reduce the power harmonics in the integrated power system by using a Multi-pulse converters and passive filtering which come to good results in THDi reduction [7].

## 2. MEASUREMENT OF TOTAL HARMONIC DISTORTION

The total harmonic distortion value must be kept under the international recommended standard level. The most well-known standard is the IEEE 519-1992 standard level. According to this standard, each harmonic should be less than or equal to 3% and the THD must be lower than or equal to 5% [8].

The THD represent the summation of all harmonics of voltage or input current waveform compared with the fundamental component of this voltage or input current, which can be calculated as follows [9]:

$$THDv = \frac{\sqrt{V_2^2 + V_3^2 + V_4^2 + \dots + V_n^2}}{V_1} \times 100\% \quad (1)$$

$$THDi = \frac{\sqrt{I_2^2 + I_3^2 + I_4^2 + \dots + I_n^2}}{I_1} \times 100\% \quad (2)$$

where

*THDi* Total high distorted input current.

*THDv* Total high distorted supply voltage.

Harmonics produced by nonlinear loads can be reduced by some methods such as, adding passive filter reactor in AC side, serial line inductance in AC side or DC filter in DC side [9]. This paper was interested in studying and analysis the impact of adding a serial inductor in AC side of a 3-phase 6-pulse diode bridge on the reduction of current THD. The 3-phase 6-pulse diode bridge rectifier was chosen due to it corresponds to the operation of the 6-pulse thyristor bridge rectifier at maximum load (with keeping the angle  $\alpha = 0$ ). When current through the inductor changes, some voltage will be induced across its terminals with opposite direction of the applied voltage WHICH LEED to reduce the THD [10].

Measurements are conducted by gradually increasing the series inductance value in the AC side. The serial inductive reactance (*X%*) was used in the analysis instead of inductance *L* and it can be calculated as follows [11]:

$$X\% = \frac{l_1 2\pi f L}{U} \times 100\% = \frac{l_1 X_L}{U} \times 100\% \quad (3)$$

where

*I<sub>1</sub>* Rated current of first harmonic, (A).

*L* Phase inductance, (H).

*U* Phase voltage, (V).

*f* Frequency, (Hz)

*X* Phase reactance, (Ω)

The simulation model was performed using Simulation work is done utilizing the MATLAB / Simulink programming results have been displayed to accept the hypothesis. Fig. 1 shows the simulation model of 3ph-6 pulse bridge rectifier.

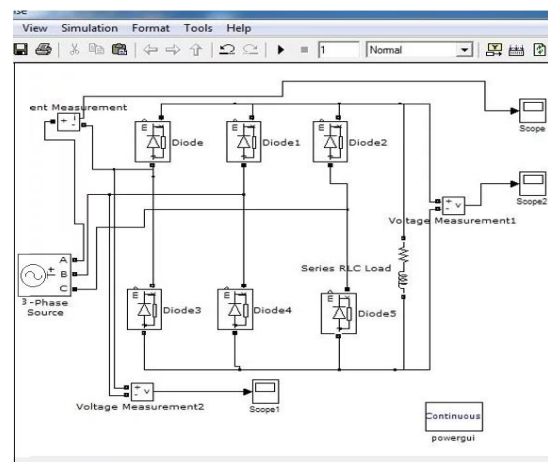

Fig. 1. Simulation model of 3ph-6 pulse bridge rectifier.

## 3. RESULTS AND DISCUSSION

Measurement started with measuring the THD current in the circuit without adding serial inductance, then the measurement is repeated with adding serial inductance for three different. Results of serial inductive reactance (*X%*) are indicated in Table 1.

Table 1

Results of decreasing the (*THDi*) due to increasing the serial inductance (*X%*).

X%	THDi (%)	Harmonic current (Ii%)	cosφ	power factor
0.0	29.16	23	1.0	1.0
8.7	23.70	21	0.9	0.96
41.9	9.83	7	0.8	0.83
67.5	4.61	4	0.7	0.68

For *X%* = 0% (without adding serial inductance), the *THDi* = 29.16%. This level considers a high level especially in fifth and seven harmonics with power factor = 1 as shown in Fig. 2.

For *X%* = 8.7% (with adding serial inductance), the *THDi* = 23.7%. This level also considers a high level (above the recommended standard level: 23%>5%) with power factor = 0.96. This results shows some reduction in the THD level, but with some reduction power factor as shown in Fig. 3.

For  $X\% = 41.9\%$ , the  $THDi = 9.8\%$ . This level also considers a high level (above the recommended standard level:  $23\% > 5\%$ ) with power factor  $=0.86$  as shown in Fig. 4.

For  $X\% = 67.5\%$ , the  $THD = 4.6\%$  which is lower than the standard level: ( $4.5\% < 5\%$ ), so it is acceptable level with power factor  $=0.68$ . As shown in Fig. 5.

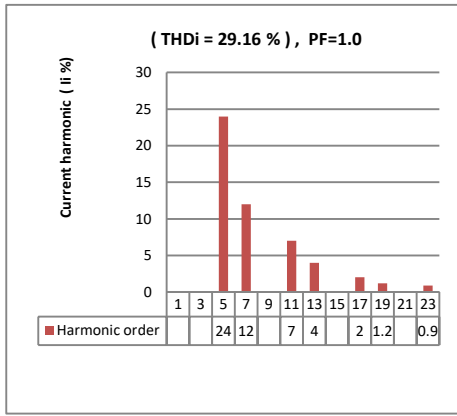

Fig. 2. Harmonic current spectrum for  $X\% = 0\%$ .

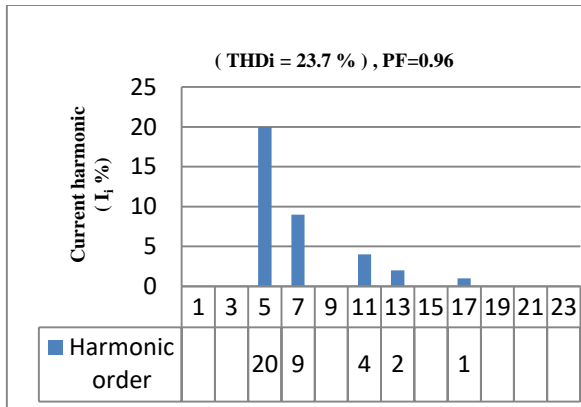

Fig. 3. Harmonic spectrum of current  $\% = 41.9\%$ .

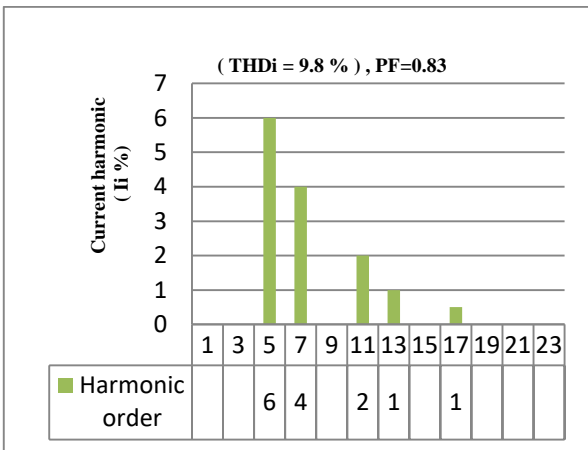

Fig. 4. Harmonic spectrum of current  $\% = 41.9\%$ .

Fig. 6 shows a comparison between the four results, which indicate the effect of increasing the serial inductance value on the reduction of the THD.

Based on the results obtained, we can conclude that: By gradually increasing the value of adding serial inductance, some improvement in THD reduction has been achieved as shown in Fig. 7. The results also indicate that, with a gradually increasing the serial inductance, some

reduction in power factor has been recorded as shown in Fig. 8.

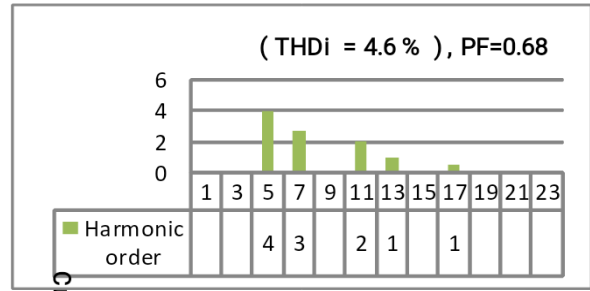

Fig. 5. Harmonic spectrum of current  $\% = 41.9\%$ .

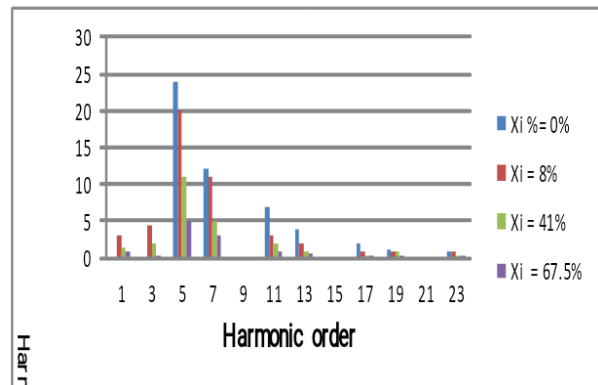

Fig. 6. Comparison between the four results.

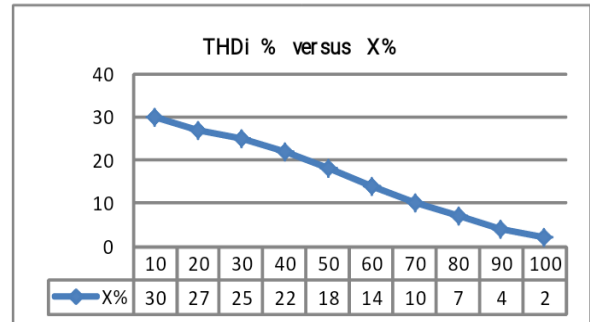

Fig. 7. Total current harmonic distortion versus serial inductance.

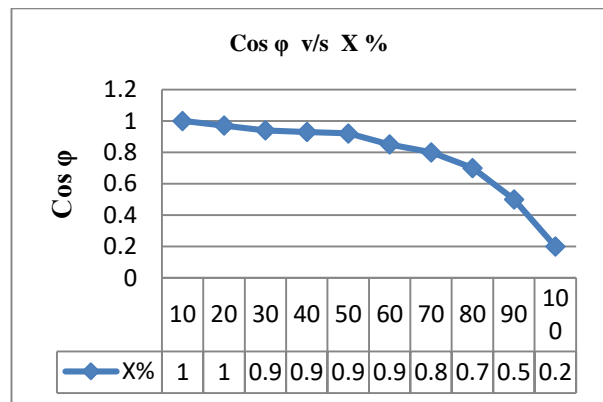
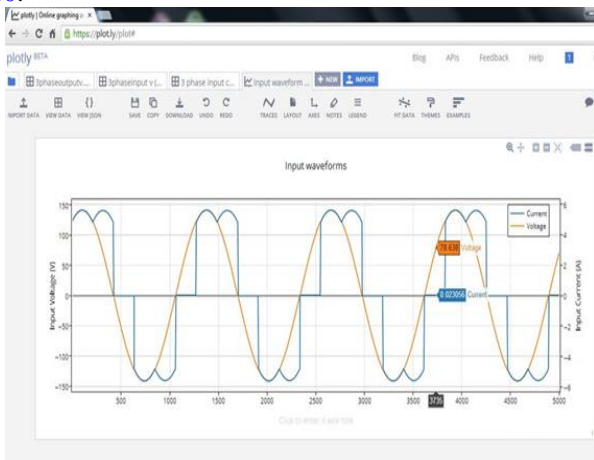

Fig. 8. Power factor value versus serial inductance.

By comparison the results obtained, we can see that all the level of THD results by increasing the serial inductive reactance ( $X_i$ ) are higher than acceptable levels recommended by the IEEE 519-1992 standard level except

when its value exceed (67%), which results in  $THD = 4.6\%$ . This level is lay within acceptable level.

The shape of wave forms without serial inductance high THD is discontinues, while after adding the serial inductor, the shape tends to be continues and approximately has a sinusoidal shape as illustrated in Figs. 9 and 10.



**Fig. 9.** Input current and input voltage to rectifier before adding serial inductance.

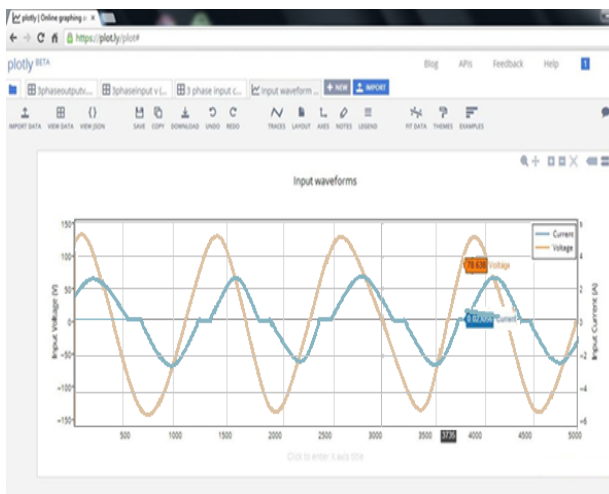

**Fig. 10.** Input current and input voltage to rectifier after adding serial inductance.

#### 4. CONCLUSIONS

In this paper, a study has been carried out to investigate the effect of increasing the serial inductance on reduction the input current distortion. A 3-phase 6-pulse rectifier has been modeled using the Alternative Transients Program (ATP). Both voltage and current harmonics are obtained as well as the value of the generated harmonic distortion. Results indicates that for high values of serial inductance, there is good reduction in the THD of the input current in AC side with a relatively some reduction in power factor. By comparison the results obtained, we can see that all the level of THD results by increasing the inductive reactance ( $X_i$ ) are higher than acceptable levels recommended by the IEEE 519-1992 standard level except when its value exceed (67.5%) in which results of  $THD = 4.6\%$  which is lay within acceptable level. From result analyzing, it was found that a three-phase 6-pulse rectifier produces 29.7% of harmonic distortion, which is above the

acceptable levels recommended by the IEEE 519-1992 standard, so for batter operation of the 3-ph 6- pulse rectifier, it is necessary to add a serial inductor in the AC side of the drive.

#### References

- [1] Laaksonen M. Fourier'n menetelmät. Lecture handout. Tampere University of Technology; Tampere, Finland: 2013.
- [2] Baggingi A. Handbook of power quality. Chichester, West Sussex, England: John Wiley & Sons; 2008.
- [3] Saastamoinen J. Jännitetasojen vertailu laivan sähköverkossa. Ph.D. Thesis. Metropolia University of Applied Sciences; Helsinki & Vantaa & Espoo, Finland: 2013.
- [4] Bhat AH, Agarwal P. Improved power quality AC/DC converters. *Power Quality: InTech*; 2011. pp. 271–310.
- [5] Radan D. Power electronic converters for ship propulsion electric motors. *Marine Cybernetics Energy Management Systems, Part of the NTNU project All Electric Ship, Department of Marine Technology, NTNU* 2004.
- [6] El-Ela AA, Allam S, El-Arwash H. An optimal design of single tuned filter in distribution systems. *Electric Power Systems Research* 2008; **78** (6): 967-974.
- [7] Maes W. Marine electrical knowledge. *Antwerp Maritim Academy, Belgium* 2013; pp.52.
- [8] Fitzgerald AE, Kingsley C, Umans SD, James B. Electric machinery. 6th d., McGraw-Hill; New York: 2003.
- [9] Aleem SHEA, Zobia AF, Aziz MMA. Optimal C-type passive filter based on minimization of the voltage harmonic distortion for nonlinear loads. *IEEE Transactions on Industrial Electronics* 2012; **59** (1): 281-289.
- [10] Ådnanes AK. Maritime electrical installations and diesel electric propulsion. ABB AS Marine, Oslo: 2003.
- [11] Ku DC. Multi-pulse converters and passive filtering to improve power harmonics in an integrated power system. MSc. Thesis, USNA, Annapolis, MD; 2014.