

College of Engineering

ISSN: 1813-162X (Print) ; 2312-7589 (Online)

Tikrit Journal of Engineering Sciences

available online at: <http://www.tj-es.com>
**TJES**  
 Tikrit Journal of  
 Engineering Sciences

Duraid F. Ahmed \*

Sahar A. Ahmed

 Chemical Engineering Department  
 College of Engineering  
 Tikrit University  
 Salahaldeen  
 Iraq

# The Dynamic Behavior and Control of Absorption Column

## ABSTRACT

The present paper deals with studying the dynamic model and control of absorption column by implementing two types of control strategies for CO<sub>2</sub> gas and NaOH solution. The control methods in this study are PID, fuzzy with five membership function. The results showed that a good improvement for CO<sub>2</sub>/Air-NaOH system with chemical reaction is achieved when the fuzzy logic with five membership function because these methods have more suitable, lower over shoot, less offset value and less integral absolute error.

### Keywords:

 Absorption  
 fuzzy logic control  
 PID control  
 Matlab/Simulink

### ARTICLE INFO

#### Article history:

 Received 13 March 2016  
 Accepted 20 December 2017  
 Available online 17 June 2018

© 2018 TJES, College of Engineering, Tikrit University

DOI: <http://dx.doi.org/10.25130/tjes.25.2.01>

## السلوك الديناميكي والسيطرة على برج الامتصاص

### الخلاصة

يتعامل هذا البحث مع الدراسة نموذج ديناميكي والسيطرة على برج الامتصاص بتطبيق نوعين من أنواع السيطرة لنظام غاز ثاني أكسيد الكربون ومحلول هيدروكسيد الصوديوم. طرق السيطرة في هذا البحث هي المسيطر من نوع التناسبي-التكاملي-التفاضلي والمنطق الضبابي ذو الخمس قواعد. النتائج عرضت أداء جيد لنظام CO<sub>2</sub>/Air-NaOH بوجود تفاعل كيميائي وتحقق الاداء عند استخدام المنطق الضبابي مع خمس دوال.

## 1. INTRODUCTION

The consideration of gas absorption under unsteady state regime is quite novel. Most gas absorption systems operate under steady state regime. Such unsteady state processes find application in a variety of chemical process industries. The absorption of carbon dioxide into sodium hydroxide is accompanied by chemical reaction to form sodium carbonate as product; this process is known as chemisorptions [1].

Olutoye and Mohammed [3] presented the modeling of a gas absorption packed column with the aim formulating a mathematical model and simulation of the model using computer software to obtain the rate of absorption and the amount of absorbed carbon dioxide CO<sub>2</sub> into dilute sodium hydroxide NaOH. The comparison between the obtained experimental and simulated results shows that the formulated model is a good representation of the system. Olytoye and Etengh [1] investigated the unsteady state behavior of gas absorption column for CO<sub>2</sub>-NaOH system was carried out using the gas absorption

column. Model equations were derived for the time dependent parameters and the model compared with experiments showed that the results of experiments showed agreement with the model results. Mores et al. [4] is developed a mathematical model of a packed column for CO<sub>2</sub> capture using aqueous monoethanolamine solution. The absorption unit model takes into account. The absorption efficiency defined as the ratio between the CO<sub>2</sub> recovery in rich solution and the packing volume of the column. The effect of the main process parameters on the optimized results was also investigated. Dowell et al. [5] proposed a dynamic non-equilibrium model of a packed column for the chemisorptions of CO<sub>2</sub> from dilute gas streams using a monoethanolamine solvent. The model uses the SAFT-VR equation of state to describe the thermo physical properties and fluid-phase behavior of this process. It has been evaluated through dynamic simulation the effect of changing the lean solvent flow rate and thermodynamic state on column behavior. The influence of flue gas humidity on the position and shape of the mass transfer zone is also highlighted and discussed. Asendrych et al. [5] applied numerical modeling of carbon dioxide

\* Corresponding author: E-mail : [drduraid1@yahoo.com](mailto:drduraid1@yahoo.com)

capture by amine solvent from flue gases in post-combustion technology. A complex flow system including a countercurrent two-phase flow in a porous region, chemical reaction and heat transfer is considered to resolve CO<sub>2</sub> absorption. Good consistency of numerical results with experimental data acquired at a small-scale laboratory CO<sub>2</sub>.

Control plays a fundamental role in modern technological systems. The benefits of improved control in industry can be immense include improved product quality, reduced energy consumption, minimization of waste material, increased safety levels, and reduction of pollution. Bedelbayev et al. [7] studied CO<sub>2</sub> capture by post-combustion using monoethanolamine. The mechanistic model for the absorption process is elaborated and includes specie and energy balances for the liquid and gas phases. Model predictive control is implemented as a control strategy for the absorption column. The developed mathematical model of the absorption tower is compound of several nonlinear elements acting in combination with each other in the model and causing high nonlinearity. The MPC showed good results for the disturbance attenuation, and was able to handle relatively large changes in set point and disturbance variables. Harun et al. [8] studied a dynamic model for the complete monoethanolamine absorption process to study the operability of this process in a dynamic fashion. A basic feedback control strategy based on Proportional-Integral (PI) controllers was developed and implemented using this dynamic model to study the closed-loop performance of this system under the effect of external perturbations. Eyng et al. [9] investigated the development of a nonlinear controller, based on a neural network inverse model (ANN controller), was proposed and tested to manipulate the absorbent flow rate in order to control the residual ethanol concentration in the effluent gas phase. The results demonstrated that ANN controller was a robust and reliable tool to control the absorption

Rate of accumulation of component mass = Input of component mass rate

$$- \text{Out of output of component mass rate} - [\text{volume of the column} \times (\pm \text{Rate of reaction})] \quad (2)$$

$$M \left( \frac{dx_1}{dt} \right) = [g_1(t) y_1(t) + L_2 x_2(t)] - [g_2(t) y_2(t) + L_1 x_1(t)] - [V \times (kx_1)] \quad (3)$$

column. Attarakiha et al. [2] developed mathematical model, which consists of a system of differential and algebraic equations using MATLAB and SIMULINK to simulate steady state, open and closed loop dynamics of a sieve tray gas absorption column. The controlled variable was found to exhibit fairly large overshoots due to step change in the inlet gas flow rate, while the PID controller performance was satisfactory for step change in the inlet gas composition. The closed-loop dynamic analysis showed that the controlled variable (outlet gas phase composition) had a fairly linear dynamic due to step changes in the set point.

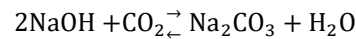
The objective of this work is to develop an unsteady state and dynamic models for the mass balance of packed bed absorption column. The developed models are programmed in MATLAB and SIMULINK flow sheet software. The combination of simulink and matlab is utilized to develop an industrial feedback control system for a general packed bed gas absorption column with only one solute transfer. Both theoretical and experimental

studies on packed bed absorption column are carried out. This circumstances allows for a particle way to develop a control block diagram including measuring device feedback controllers and final control element, implementation of PID, fuzzy logic controller on absorption column and a comparison between the two control strategies is made to observe the best control method that can be recommended for the gas concentration absorption system and to test the effectiveness of these controllers on the behavior of the system.

## 2. ABSORPTION OF CO<sub>2</sub>

The absorption process is presented a dynamic behavior and mass transfer model for a general binary gas absorption column, the inlet Composition of the absorption column is homogenous and the Concentration of inlet liquid is constant. The temperature effect is negligible, the absorption process is under atmospheric pressure, the gas holds up is constant, and the density of the solution is constant.

The chemical reaction is:



The rate of reaction is [10]:

$$r_A = 2.4956 \times 10^{-5} e^{\left( \frac{8057.1398}{RT} \right)} (\text{CO}_2)^{1.28} \quad (1)$$

The absorption process divided in two types:

### CO<sub>2</sub>-Naoh System with Chemical Reaction

The assumptions in this system are: the inlet gas flow rate ( $g_1$ ) is unequal to out gas flow rate ( $g_2$ ), the mole fraction of inlet gas is equal to the mole fraction outlet gas ( $y_1=y_2$ ). The inlet liquid flow rate is equal to the outlet liquid flow rate ( $L_1 = L_2 = L$ ), the inlet liquid is pure, ( $x_2 = 0$ ).

The derivative equation is:

$$Tp \left( \frac{dx_1}{dt} \right) = k_2(t) g_1(t) + k_2 g_2(t) \quad (4)$$

$$G(s) = \frac{x_1(s)}{g_1(s)} = \left( \frac{k_1}{Tp_s} + 1 \right) \left[ 1 - \frac{g_2(s)}{g_1(s)} \right] \quad (5)$$

While:

$$Tp = M/L + Vk, \quad k_2 = 1/L + Vk$$

where  $M$  is the liquid holdup,  $x_1$  is the concentration of CO<sub>2</sub> absorbed in liquid, and  $y_1$  is the concentration of CO<sub>2</sub> in gas.

### CO<sub>2</sub>/Air-NaOH System with Chemical Reaction

The assumptions in this system are: the inlet gas flow rate ( $g_1$ ) is equal to out gas flow rate ( $g_2$ ), the mole fraction of inlet gas is unequal to the mole fraction outlet gas ( $y_1 \neq$

$y_2$ ). The inlet liquid flow rate is equal to the outlet liquid flow rate ( $L_1 = L_2 = L$ ), and the inlet liquid is pure, ( $x_2 = 0$ ). The derivative equation is:

$$Tp \left( \frac{dx_1}{dt} \right) + x_2(t) = k_4 [y_1(t) + y_2(t)] \quad (6)$$

The transfer function is:

$$x_1(s) = \left( \frac{k_4}{Tp_s} + 1 \right) y_1(s) + \left( \frac{k_4}{Tp_s} + 1 \right) y_2(s) \quad (7)$$

### 3. SIMULATION WORK

A simulation program is built for the absorption by using the program MATLAB /Simulink version (R2011a) from (Math works), which are a software modeling dynamical systems and simulation and analysis, whether linear or non-linear. By using Simulink, we can build models from scratch or amendment to existing models and of interest is the study of the characteristics of control and dynamic situation. The mathematical model is built for the absorption in the form of a set of systems, and each system component with a set of subsystems which represents the mathematical model equations for absorption. The simulation results are showed qualitatively acceptable behavior for all systems. The model is developed consists of differential and algebraic equations that validated using a parameter sensitivities method that uses data collected in the industrial plant. Tables 1 and 2 show the simulation runs that have been made using a simulation program to control methods system.

#### 3.1. Simulation of Open-Loop System

The unsteady step change simulation runs were conducted by introducing the gas flow rate and the liquid flow rate of the absorption tower and measuring the output concentration of CO<sub>2</sub> absorbed by the liquid (caustic soda) in the absorption column by two types of the system, as shown in Figs 1 and 2.

**Table 1**

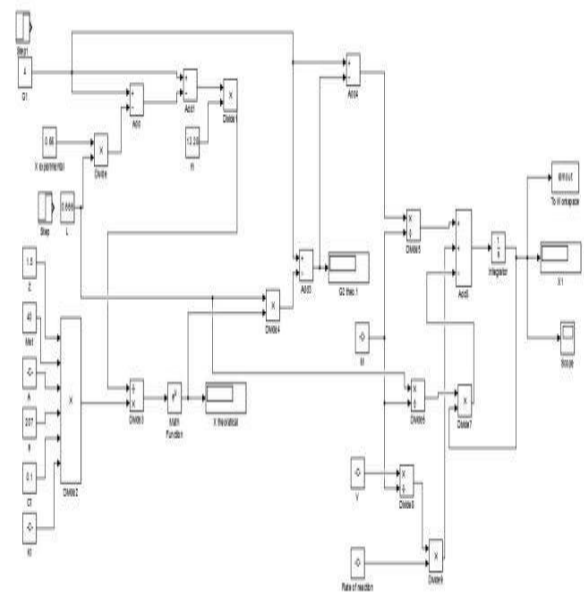
Simulation runs for dynamic systems.

Run no.	Type of disturbance	Value of step change	System
1	gas flow rate, (L/min)	4-8	CO <sub>2</sub> -NaOH with chemical reaction
2	gas flow rate, (L/min)	8-12	
3	liquid flow rate, (L/min)	0.666-1.333	
4	liquid flow rate, (L/min)	1.333-2	
5	gas flow rate, (L/min)	4-8	CO <sub>2</sub> /Air-NaOH with chemical reaction
6	gas flow rate, (L/min)	8-12	
7	liquid flow rate, (L/min)	0.666-1.333	
8	liquid flow rate, (L/min)	1.333-2	

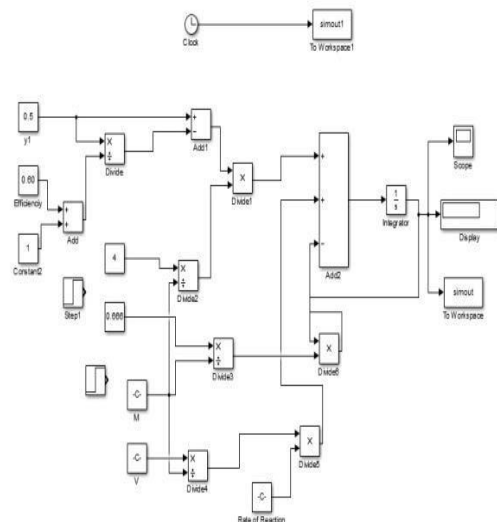
**Table 2**

Simulation runs for control methods system.

Run no.	Type of disturbance	Value of step change	System
1	gas flow rate, (L/min)	4 - 8	CO <sub>2</sub> -NaOH with chemical reaction
2	gas flow rate, (L/min)	8 - 12	
3	liquid flow rate, (L/min)	0.666-1.333	
4	liquid flow rate, (L/min)	1.333-2	
5	gas flow rate, (L/min)	4 - 8	CO <sub>2</sub> /Air-NaOH with chemical reaction
6	gas flow rate, (L/min)	8 - 12	
7	liquid flow rate, (L/min)	0.666-1.333	
8	liquid flow rate, (L/min)	1.333-2	



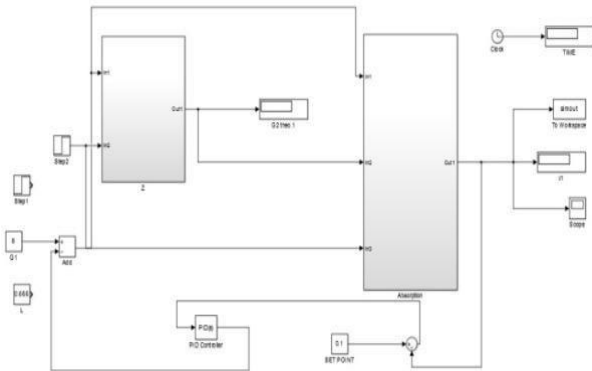
**Fig.1.** Simulation work of CO<sub>2</sub>-NaOH with chemical reaction system.



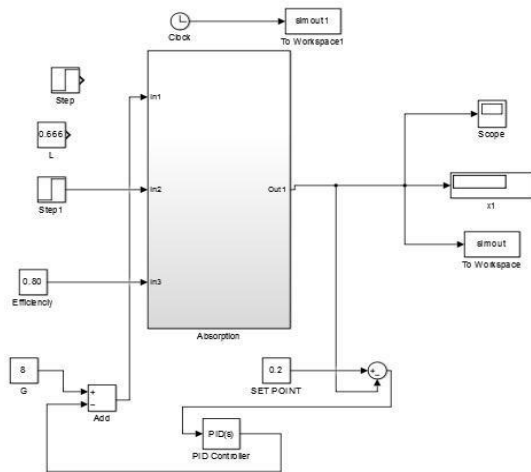
**Fig. 2.** Simulation work of CO<sub>2</sub>/Air-NaOH with chemical reaction system.

**3.2. Simulation of the PID Control System**

After running the dynamic model that has been developed using Simulink and determining the extent of the system's response to some of the changes, as shown in Figs. 3 and 4.



**Fig. 3.** PID control of CO<sub>2</sub>-NaOH with chemical reaction subsystem.



**Fig. 4.** PID control of CO<sub>2</sub>/Air-NaOH with chemical reaction subsystem.

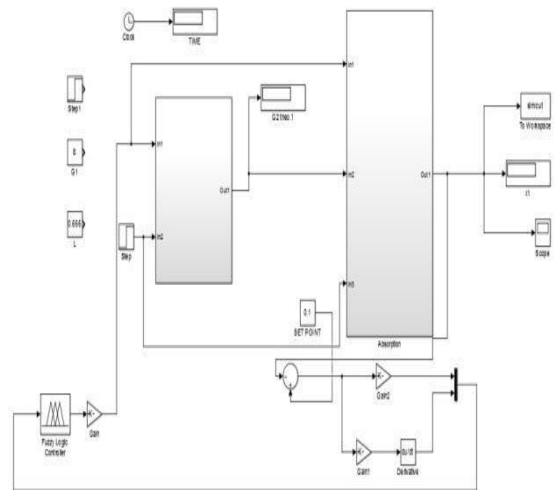
**3.3. Simulation of Fuzzy Control System**

After running the dynamic model that has been developed using Simulink and determining the extent of the system's response with changes, the control system is run for this model using fuzzy control method (fuzzy logic), as shown in Figs. 5 and 6.

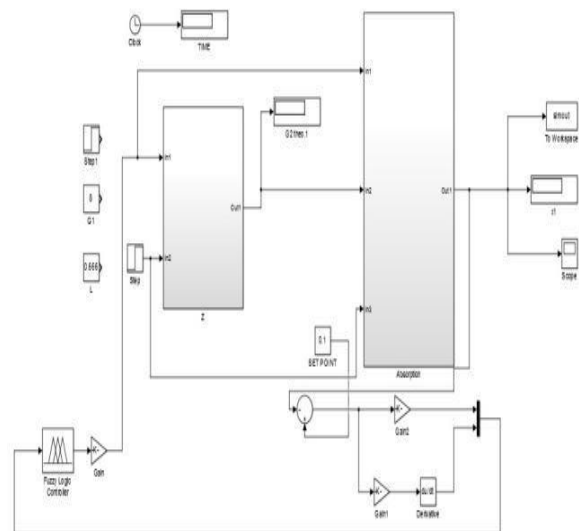
**3.4. The System Studied**

The system used in this study is CO<sub>2</sub>- NaOH and the schematic diagram of the experimental arrangement of absorption tower is shown below in Fig. 7. A 1.5 m height, 0.20 m diameter, and 1 m height of packing glass column is employed. The size of plastic reaching ring is 2.5 mm with bulk density of 88 kg/min<sup>3</sup>, surface area is 207 m<sup>2</sup>/m<sup>3</sup> and packing factor is 170 m<sup>-1</sup>. 100-liter stainless steel tank is used as feed tank of liquid solution. The transfer of liquid is achieved by centrifugal pump. The liquid flow rate is measured by independently calibrated rotameters. The range of flow of rotameter that was used in laboratory is

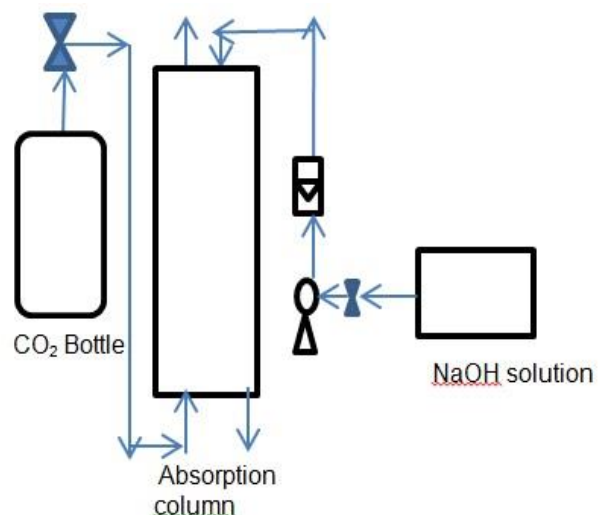
(0-40-80-120-180 L/hr) of water at(20°C). A CO<sub>2</sub> bottle with gas flow meter is used as feed tank of CO<sub>2</sub> [11].



**Fig. 5.** The fuzzy control of CO<sub>2</sub>-NaOH with chemical reaction subsystem.



**Fig. 6.** The fuzzy control of CO<sub>2</sub>/Air-NaOH with chemical reaction subsystem.



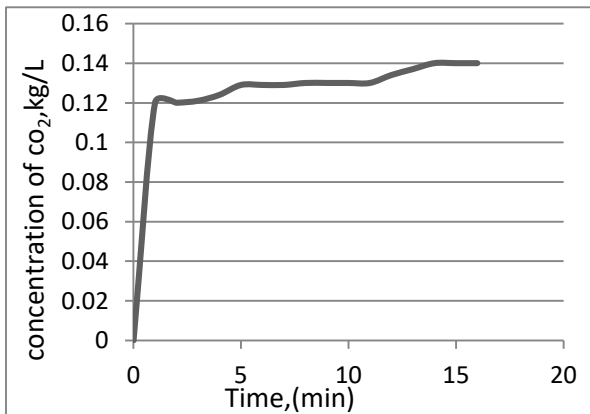
**Fig. 7.** The schematic diagram of absorption process.

#### 4. RESULT AND DISCUSSION

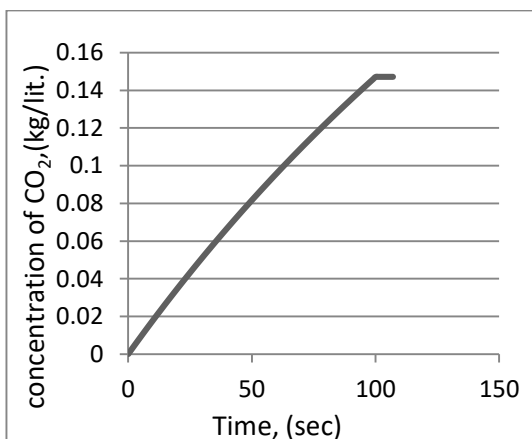
Experimental and Simulation results for the absorption concentration responses for different step changes in the gas flow rate and the liquid flow rate were obtained in simulation for the tow systems and make a comparison between simulation and experimental results.

##### 4.1. Effect of Gas Flow Rate

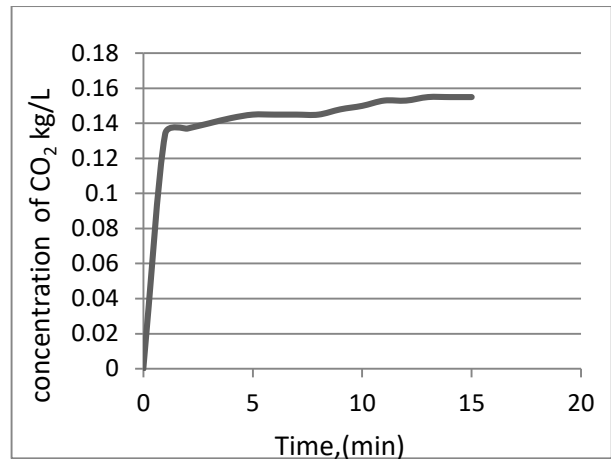
In Figs. 8-11, it can be observed from the Figures that the concentration of CO<sub>2</sub> in experimental need so many time to reach to steady state while in simulation need less. In experimental the concentration is (0.14 kg/L) with step change (4 to 8 L/min) and (0.155 kg/L) with step change from (8 to 12 L/min) and in simulation is (0.106 kg/L). It showed that when the system CO<sub>2</sub>-NaOH with chemical reaction, the concentration still did not change with increase in gas flow rate from (4 to 8 L/min) and from (8 to 12 L/min) but the concentration increase to (0.144 kg/L) because of the value of rate of reaction. For CO<sub>2</sub>-NaOH system, the flow of liquid is steady state and the increase here only on gas flow (assuming 100% CO<sub>2</sub>) so the concentration will not effect because of the liquid would take the same amount of gas that the liquid need for the reaction, so that the increase in gas flow rate will make no difference because 0the liquid is steady state.



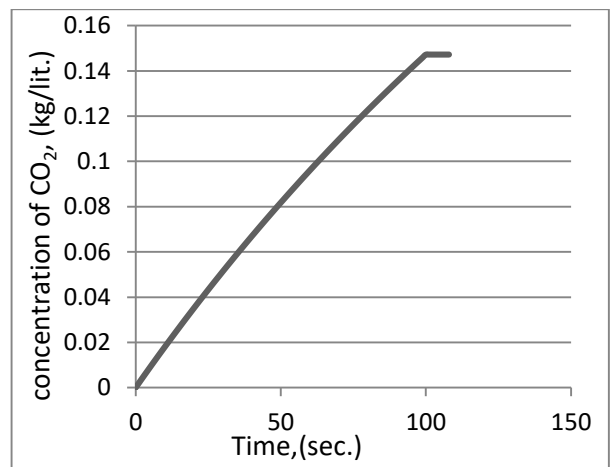
**Fig. 8.** The response of CO<sub>2</sub> concentration in NaOH solution at experimental a step change in the gas flow rate from 4 to 12 L/min for CO<sub>2</sub>-NaOH system.



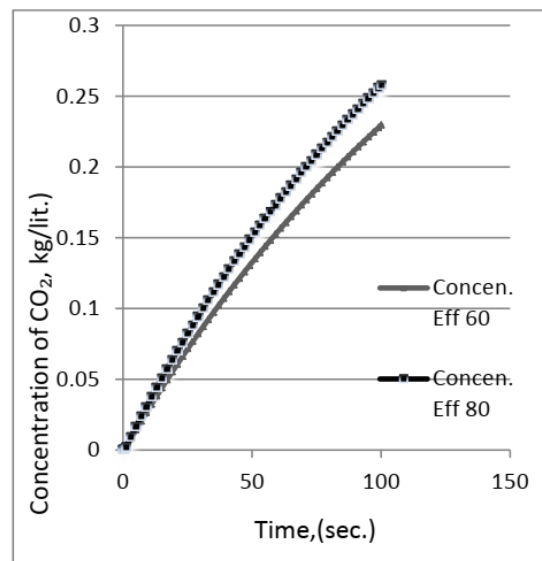
**Fig. 9.** The response of CO<sub>2</sub> concentration in NaOH solution at simulated a step change in gas flow rate from 4 to 8 L/min for CO<sub>2</sub>-NaOH with chemical reaction system.



**Fig. 10.** The response of the CO<sub>2</sub> concentration in the NaOH solution at experimental a step change in the gas flow rate from 8 to 12 L/min for the CO<sub>2</sub>-NaOH system.

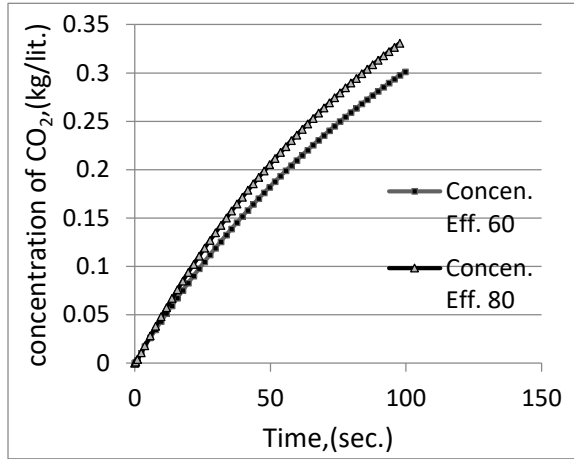


**Fig. 11.** The response of the CO<sub>2</sub> concentration in the NaOH solution for simulated a step change in the gas flow rate from 8 to 12 L/min for the CO<sub>2</sub>-NaOH with chemical reaction system.



**Fig. 12.** The response of CO<sub>2</sub> concentration in NaOH solution at simulated a step change in the gas flow rate from 4 to 8 L/min for CO<sub>2</sub>/Air- NaOH with chemical reaction system.

In Figs 12 and 13, it showed that system  $\text{CO}_2/\text{Air}$  with chemical reaction with a step change in the gas flow rate, the concentrations will increase with increase in gas flow rate. When the gas flow rate up from 4 to 8 L/min the concentration when the efficiency 60% equal to 0.229 kg/L and in 80% equal to 0.257 kg/L and when increase the gas flow rate from 8 to 12 L/min. The concentration when efficiency 60% equal to 0.301 L/kg and when 80% equal to 0.330 kg/L.

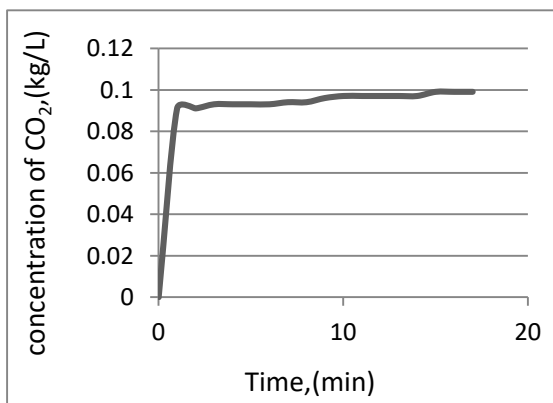


**Fig. 13.** The response of  $\text{CO}_2$  concentration in NaOH solution at simulated a step change in the gas flow rate from 8 to 12 L/min for  $\text{CO}_2/\text{Air}$ - NaOH with chemical reaction system.

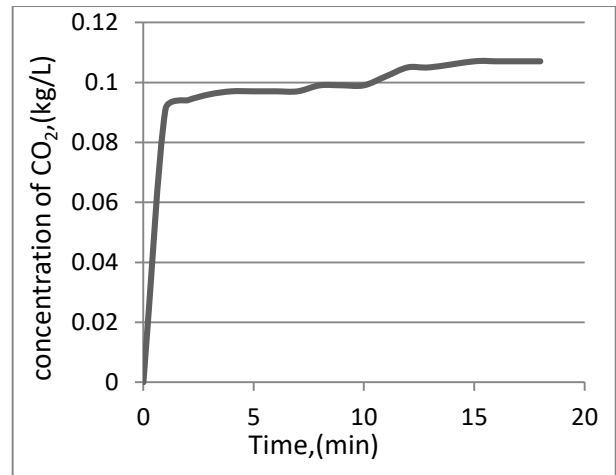
#### 4.2. Effect of Liquid Flow Rate

Fig. 14 shows that experimental response of the outlet concentration of carbon dioxide to step change in the liquid concentration increases from 0.093 to 0.099 kg/L. Fig. 15 shows the experimental response with a step change in liquid from (1.333 to 2 L/min), the concentration increase from 0.097 to 0.107 kg/L.

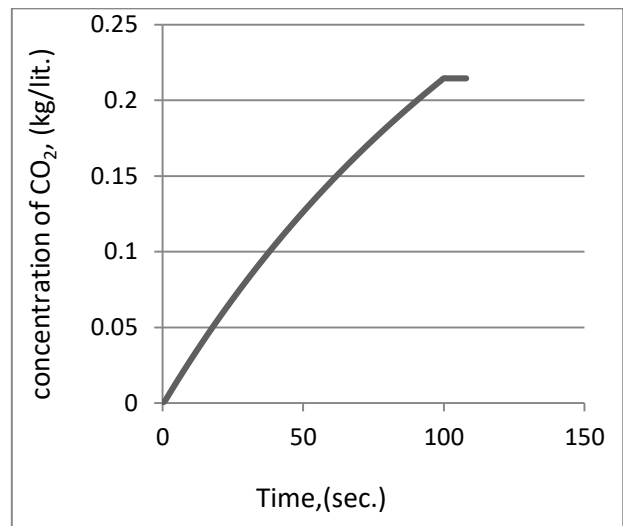
The outlet concentration of  $\text{CO}_2$  response for  $\text{CO}_2$ -NaOH with chemical reaction is shown in Figs. 16 and 17, these figures show that the concentration is increasing with increase in liquid flow rate. In Fig. 16 the concentration reach to (0.2144 kg/L) with a step change in the liquid flow rate from (0.666 to 1.333). In Fig. 17 the concentration reach to (0.266 kg/L) with increasing the step change in the liquid flow rate from (1.333 to 2 L/min).



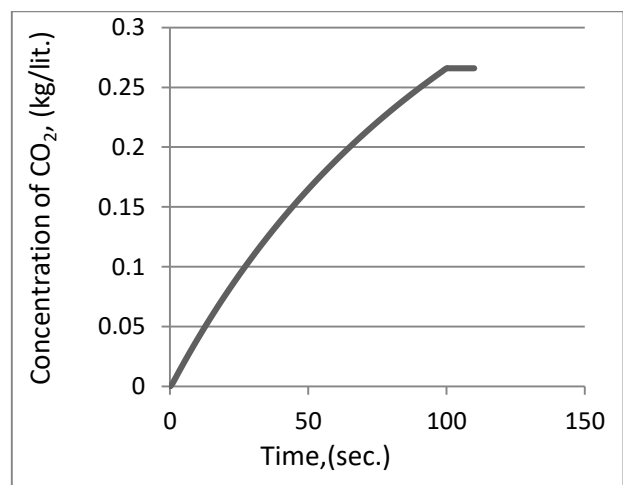
**Fig. 14.** The response of  $\text{CO}_2$  concentration in NaOH solution at experimental a step change in the liquid flow rate from 0.666 to 1.333 L/min for  $\text{CO}_2$ -NaOH system.



**Fig. 15.** The response of  $\text{CO}_2$  concentration in NaOH solution at experimental a step change in the liquid flow rate from 1.333-2 L/min for  $\text{CO}_2$ -NaOH system.



**Fig. 16.** The response of  $\text{CO}_2$  concentration in NaOH solution at simulation a step change in the liquid flow rate from (0.666 to 1.333 L/min) for  $\text{CO}_2$ -NaOH with chemical reaction system.



**Fig. 17.** The response of  $\text{CO}_2$  concentration in NaOH solution at simulation a step change in the liquid flow rate from 1.333 to 2 L/min for  $\text{CO}_2$ -NaOH with chemical reaction system.

**Table 3**Cohen-Coon parameters of the PID controller for CO<sub>2</sub>-NaOH systems.

No.	Variable of step change	Value of step change	Kc	$\tau_I$	$\tau_D$	system
1	Gas flow rate(L/min)	4-8-12	13.3	0.24	0.036	Experimental CO <sub>2</sub> -NaOH system
2	liquid flow rate (L/min)	0.666-1.333-2	1.27	1.5	0.24	
3	Gas flow rate (L/min)	4 - 8	1.106	1.08	0.171	
4	Gas flow rate (L/min)	8 - 12	0.97	1.27	0.203	CO <sub>2</sub> -NaOH with chemical reaction
5	liquid flow rate (L/min)	0.666-1.333	3.58	0.304	0.047	
6	liquid flow rate (L/min)	1.33 -2	2.09	0.528	0.081	

**Table 4**Cohen-Coon parameters of the PID controller for CO<sub>2</sub>/Air-NaOH systems.

No.	Efficiency value	Variable of step change	Value of step change	Kc	$\tau_I$	$\tau_D$	system
1	60%	gas flow rate, (kg/min)	4 - 8	5.75	0.214	0.032	CO <sub>2</sub> /Air-NaOH with chemical reaction
2		gas flow rate, (kg/min)	8 - 12	1.075	0.4	0.06	
3		liquid flow rate, (kg/min)	0.666-1.333	4.314	0.26	0.04	
4		liquid flow rate (kg/min)	1.333-2	3.87	0.282	0.042	
5	80%	gas flow rate, (kg/min)	4-8	2.44	0.26	0.04	
6		gas flow rate (kg/min)	8-12	0.94	0.43	0.067	
7		liquid flow rate, (kg/min)	0.666-1.333	3.86	0.283	0.042	
8		liquid flow rate, (kg/min)	1.333-2	3.4	0.328	0.05	

## 5. CONTROL OF ABSORPTION

The PID method is used and compared with Fuzzy control method.

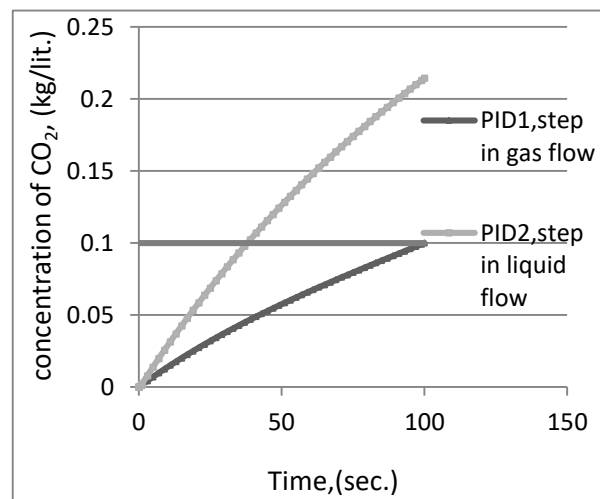
### 5.1. PID Controller

The process reaction curves method developed by Cohen- Coon method is used for determining the values of the controller parameters which required the transient responses for outlet concentration of absorption to step change in the gas flow rate and step change in the liquid flow rate. Table (3) and (4) includes our attempts to tuning parameter of PID controller. Response of concentration of absorption column using PID feedback controller to step change in the gas flow rate and step change in the liquid flow rate are done on the simulation program for PID controller.

#### Proportional Integral Derivative Controller for CO<sub>2</sub>-NaOH with Chemical Reaction System

It can be observed that from Figs. 18 and 19 the PID controllers display a good performance for disturbance in gas flow rate. The control action is much more aggressive can be observed for large change in the error value of the disturbance in liquid flow rate. The PID controller of CO<sub>2</sub> concentration at step change in liquid flow rate exceed the

set point (0.1), however, the controller at step change in gas flow rate keeps the concentration well with the set point.



**Fig. 18.** Concentration responses of absorption for PID controller to a step change in the gas flow rate from 4 to 8 L/min and a step change in the liquid flow rate from 0.666 to 1.333 L/min, at set point = 0.1 for the CO<sub>2</sub>-NaOH with chemical reaction system.

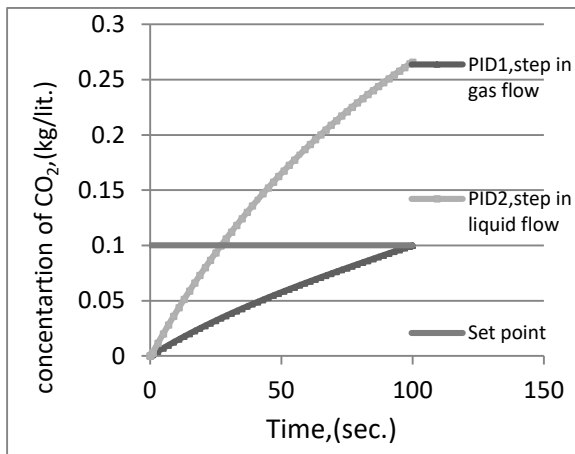
#### Proportional Integral Derivative Controller for the CO<sub>2</sub>/Air-NaOH System with Chemical Reaction

Fig. 20 shows good PID performance in control the disturbance in the concentration with a step change in the

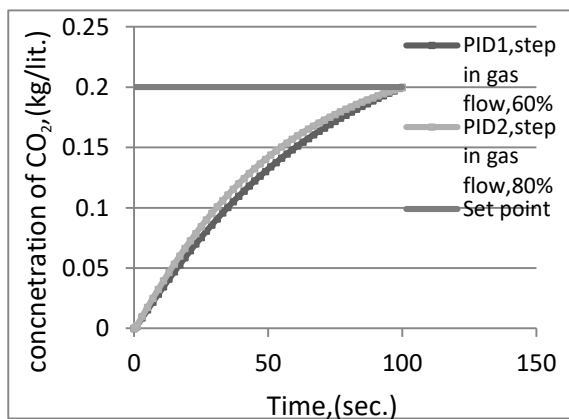
gas flow rate from 4 to 8 L/min in the both value of efficiency and equal to set point (0.2) but when the absorption work with high efficiency (80%) the control gets the set point with IAE less than (60%). In Fig. 21 when the step change in the gas becomes 8 to 12 L/min the PID also can control the concentration in the two efficiency and the values of the integral absolute error are so close. In Figs. 22 and 23 it obvious that PID show a good control in concentration with step changes in liquid 0.666 to 1.333 to 2 L/min and the IAE values for the both efficiency (60%-80%) is close too.

## 5.2. Fuzzy Logic Controller

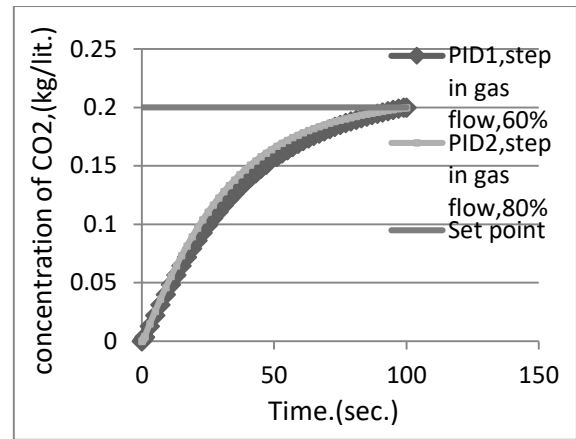
In this study, a rule base with a set of the rule form. The input and the output are related through (25) rules (Table 5). Each rule output is determined by "MIN-MAX" inference<sup>[12]</sup>. Many runs are carried out to control the outlet concentrations of absorption by using simulated fuzzy logic controller to different step disturbances in gas flow rate and in liquid flow rate.



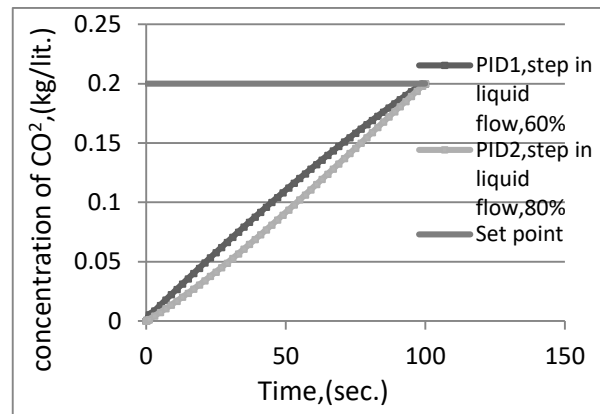
**Fig. 19.** Concentration responses of absorption for PID controller to a step change in the gas flow rate from 8 to 12 L/min and a step change in the liquid flow rate from 1.333 to 2 L/min at set point = 0.1 for CO<sub>2</sub>-NaOH with chemical reaction system.



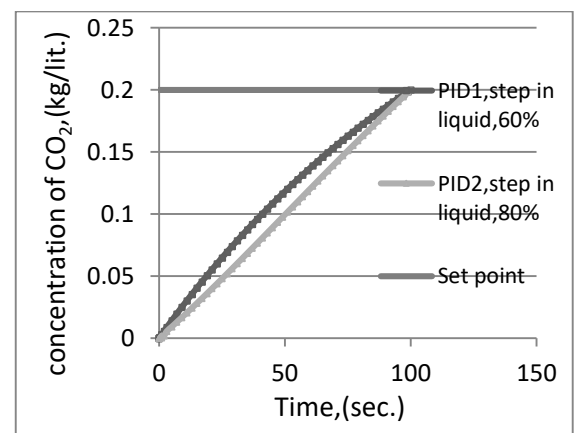
**Fig. 20.** Concentration responses of absorption for PID controller to a step change in the gas flow rate from 4 to 8 L/min at set point = 0.2 for the CO<sub>2</sub>/Air-NaOH with chemical reaction system with efficiency = 60% and 80%.



**Fig. 21.** Concentration response of absorption for PID controller to a step change in gas rate from 8 to 12 L/min at set point = 0.2 for CO<sub>2</sub>/Air-NaOH with chemical reaction system with efficiency = 60% and 80%.



**Fig. 22.** Concentration responses of absorption for PID controller to a step change in the liquid flow rate from 0.666 to 1.333 L/min set point = 0.2 for the CO<sub>2</sub>/Air-NaOH with chemical reaction system with efficiency = 60% and 80%.



**Fig. 23.** Concentration responses of absorption for PID control to a step change in liquid flow rate from 1.333 to 2 L/min set point = 0.2 for CO<sub>2</sub>/Air-NaOH with chemical reaction system with efficiency = 60% and 80%.



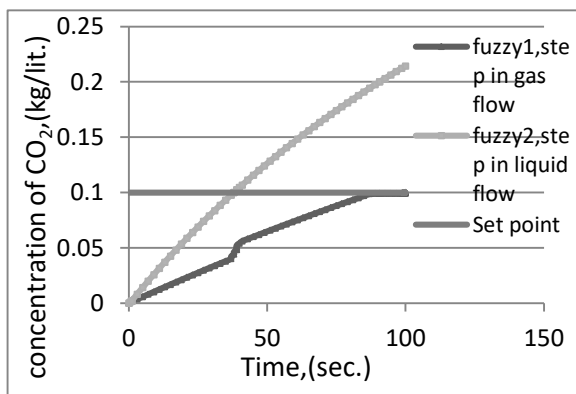
**Table 5**

Rules of the fuzzy logic controller (5MF).

	E	NB	NS	Z	PS	PB
CE						
NB	NB	NB	NB	NB	NS	Z
NS	NS	NB	NB	NS	Z	PS
Z	Z	NB	NS	Z	PS	PB
PS	PS	NS	Z	PS	PB	PB
PB	PB	Z	PS	PB	PB	PB

**Fuzzy Logic Controller for the CO<sub>2</sub>- NaOH System with Chemical Reaction**

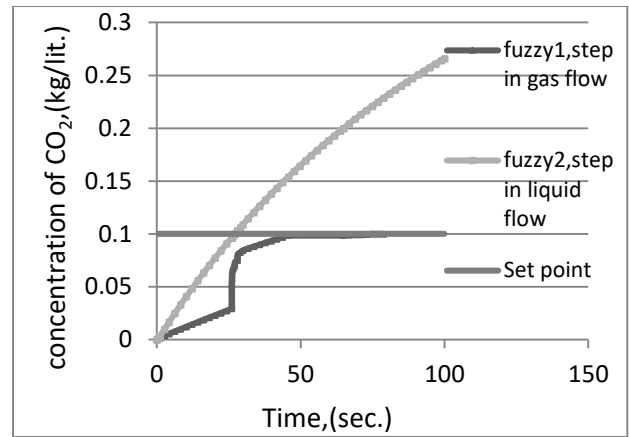
Fig. 24 shows the performance of fuzzy logic controller to control the concentration of carbon dioxide with a step change in the gas flow from 4 to 8 L/min for the CO<sub>2</sub>- NaOH system with chemical reaction and equal to set point (0.1) in (100sec) but no control on concentration with step change in the liquid from 0.666 to 1.333 L/min. It can be observed that from Fig. 25 fuzzy logic control display a good performance for disturbance in gas flow rate and get the set point with less than (60 sec). The control action is much more aggressive can be observed for large change in the error value of disturbance in liquid flow rate.



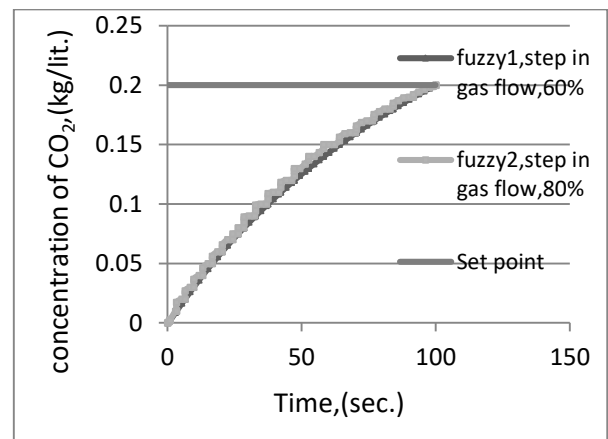
**Fig. 24.** Concentration responses of absorption under five membership functions fuzzy logic controller to a step change in the gas flow rate from 4 to 8 L/min and a step change in the liquid flow rate from 0.666 to 1.333 L/min. at set point = 0.1 for the CO<sub>2</sub>- NaOH system with chemical reaction.

**Fuzzy Logic Controller for the CO<sub>2</sub>/Air- NaOH System with Chemical Reaction**

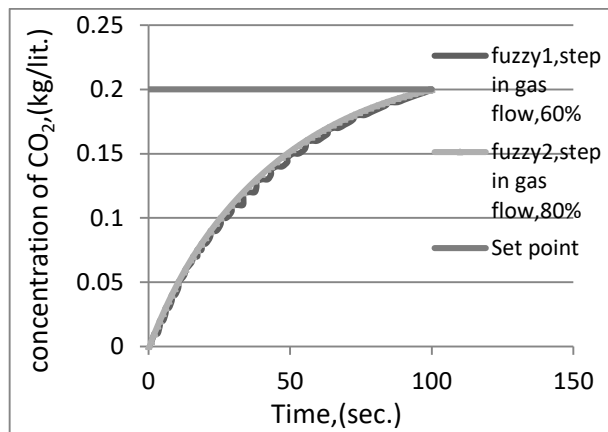
In Fig. 26 the fuzzy logic make a good control on the disturbance in concentration of CO<sub>2</sub> with efficiency 80% and equal to the set point (0.2) and control on concentration with efficiency with 60% to the set point with a step change in the gas flow rate from 4 to 8 L/min. Fig. 27 shows the concentration of carbon dioxide with efficiency is associated with disturbance but the fuzzy logic controller makes a good control and equal to the set point with a step change in the gas flow rate from 8 to 12 L/min and the concentration with efficiency 80% is controlled to set point with the same simulation time too. Figs. 28 and 29 show a good control of fuzzy logic with two efficiencies 60% and 80% on concentration of carbon dioxide with step change in liquid flow rate from 0.666 to 1.333 to 2 L/min.



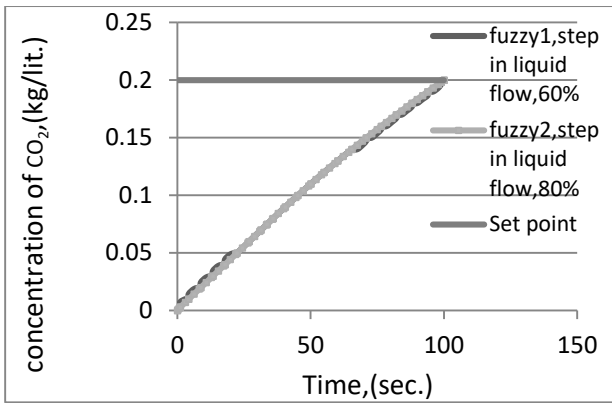
**Fig. 25.** Concentration responses of absorption under five membership functions fuzzy logic controller to a step change in the gas flow rate from 8 to 12 L/min and step change in the liquid flow rate from 1.333 to 2 L/min at set point = 0.1 for the CO<sub>2</sub>-NaOH system with chemical reaction.



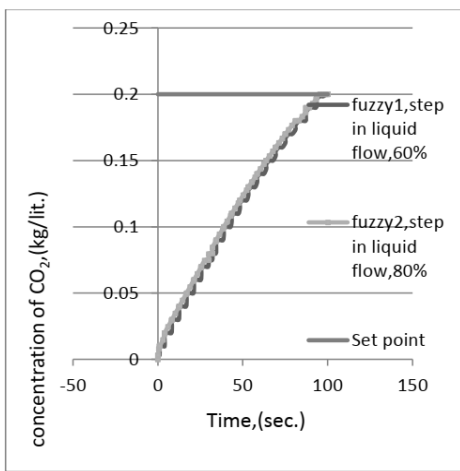
**Fig. 26.** Concentration responses of absorption under five membership functions fuzzy logic controller to a step change in the gas flow rate from 4 to 8 L/min at set point = 0.2 for the CO<sub>2</sub>/Air-NaOH system with chemical reaction with efficiency 60% and 80%.



**Fig. 27.** Concentration responses of absorption under five membership functions fuzzy logic controller to a step change in the gas flow rate from 8 to 12 L/min at set point = 0.2 for the CO<sub>2</sub>/Air-NaOH system with chemical reaction with efficiency 60% and 80%.



**Fig. 28.** Concentration responses of absorption under five membership functions fuzzy logic controller to a step change in the liquid flow rate from 0.666 to 1.333 L/min at set point =0.2 for the CO<sub>2</sub>/Air-NaOH system with chemical reaction with efficiency 60% and 80%.



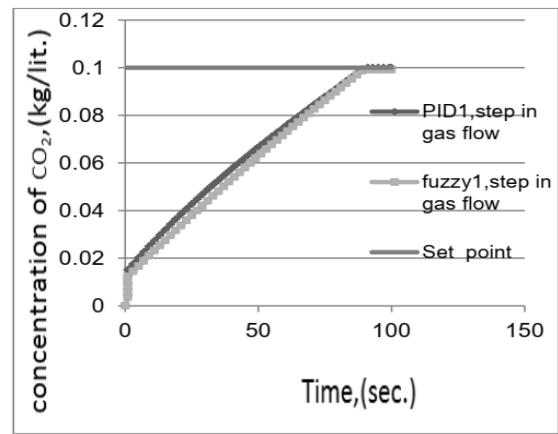
**Fig. 29.** Concentration responses of absorption under five membership functions fuzzy logic controller to a step change in the liquid flow rate from 1.333 to 2 L/min at set point = 0.2 for the CO<sub>2</sub>/Air-NaOH system with chemical reaction with efficiency 60% and 80%.

**Comparison of Concentration Control of Absorption Between Two Methods for the CO<sub>2</sub>-Naoh System with Chemical Reaction**

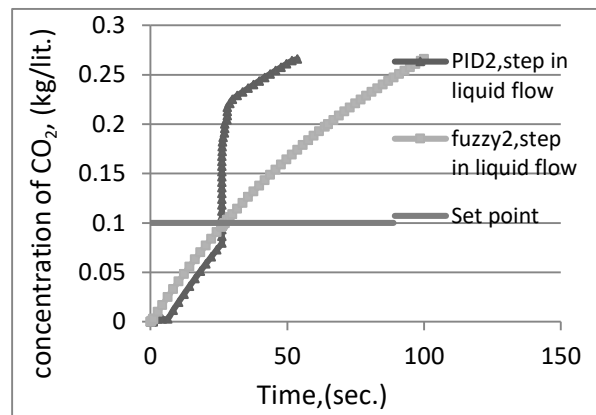
Fig. 30 shows that the compare between the PID and fuzzy controllers, the fuzzy controller show a good performance with IAE value smaller than PID controller to control the concentration of CO<sub>2</sub> with step change in gas flow rate 4 to 8 L/min. In Fig. 31 it can be noticed that the both controllers could not control the concentration with step change in liquid in flow rate from 0.666 to 1.333 L/min.

**Comparison of Concentration Control of Absorption Between the Two Methods for the CO<sub>2</sub>/Air-Naoh System with Chemical Reaction**

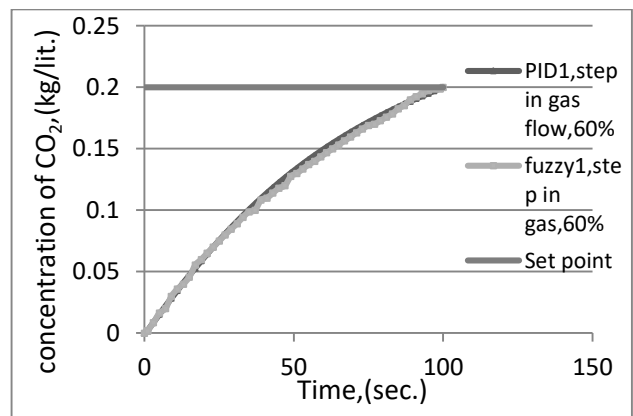
Figs. 32 and 33 show that the comparison between the PID and fuzzy controllers' performance with efficiency 60% and 80% with a step change in the gas flow from 4 to 8 L/min and the action of the two controllers are so close



**Fig. 30.** Comparison between PID and fuzzy logic five membership functions controllers in absorption to a step change in gas flow rate from 4 to 8 L/min at set point = 0.1 for the CO<sub>2</sub>-NaOH system with chemical reaction.

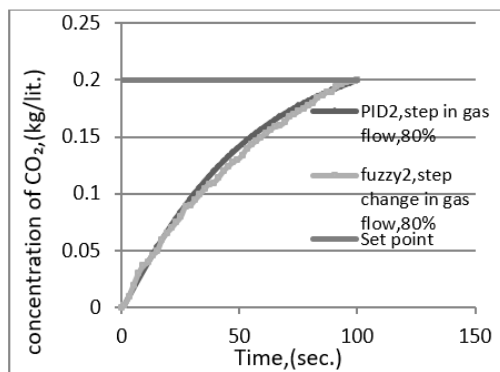


**Fig. 31.** Comparison between PID and fuzzy logic five membership functions controllers in absorption to a step change in liquid flow rate from 0.666 to 1.333 L/min at set point = 0.1 for the CO<sub>2</sub>-NaOH system with chemical reaction.

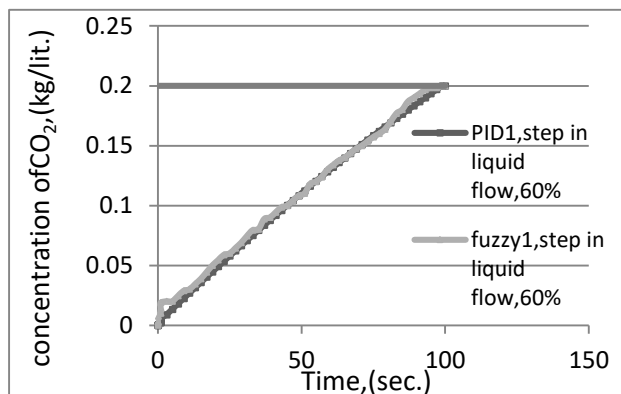


**Fig. 32.** Comparison between PID and Fuzzy logic five membership functions controllers in absorption to a step change in the gas flow rate from 4 - 8 L/min at set point of PID = 0.2 and set point of fuzzy 5M = 0.2, for the CO<sub>2</sub>/Air-NaOH system with chemical reaction with efficiency = 60%.

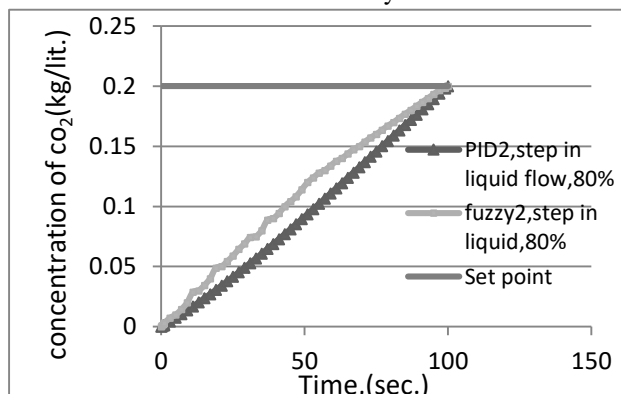
Figs. 34 and 35 show the actions of the tow controllers in step change in liquid flow rate from 0.666 to 1.333 L/min with two efficiencies, in 80% the fuzzy controller make a good performance from the PID. The Table 5 shows the comparison between the integral absolute Error between the PID and fuzzy controllers.



**Fig. 33.** Comparison between PID and fuzzy logic five membership functions controllers in absorption to a step change in the gas flow rate from 4-8 L/min at set point of PID = 0.2 and set point of fuzzy 5M = 0.2, for the CO<sub>2</sub>/Air-NaOH system with chemical reaction.



**Fig. 34.** Comparison between PID and fuzzy logic five membership functions controllers in absorption to a step change in the liquid flow rate from 0.666 to 1.333 L/min at set point of PID = 0.2 and set point of fuzzy 5M = 0.2, for the CO<sub>2</sub>/Air-NaOH system with chemical reaction with efficiency = 60%.



**Fig. 35.** Comparison between PID and fuzzy logic five membership functions controllers in absorption to a step change in the liquid flow rate from 0.666 to 1.333 L/min at set point of PID = 0.2 and set point of fuzzy 5M = 0.2, for the CO<sub>2</sub>/Air-NaOH system with chemical reaction with efficiency = 80%.

## 6. CONCLUSIONS

The transfer function of absorption tower can be regarded as a first order system with time delay. The results of the simulation work in the experimental data show that the values of concentration when makes a step change in the gas flow rate is higher than concentration with a step change in the liquid flow rate. The results in

simulation work for systems of (CO<sub>2</sub>-NaOH) with chemical reaction show that the value of concentrations with step change in liquid flow rate is higher than concentrations in gas step change. In simulation work, the process with high efficiency gets a high response of concentration than the small efficiency. Results have shown priority of fuzzy logic (five membership functions) controller in CO<sub>2</sub>/Air-NaOH with chemical reaction system which gives less offset value and the concentration response reach the steady state value in less time with lower over-shoot compared with PID controller.

## REFERENCES

- [1] Olutoye MA, Eterigho EJ. Modeling of a gas absorption column for CO<sub>2</sub>-NaOH system under unsteady-state reime. *Leonardo Electronic Journal of Practices and Technologies* 2008; (12): 105-114.
- [2] Attarakih M, Abu-Khader M, Bart H-J. Dynamic analysis and control of sieve tray gas absorption column using Matlab and Simulink. *Journal of Applied Soft Computing* 2013; 13 (2): 1152-1169.
- [3] Olutoye MA, Mohammed A. Modeling of a gas-absorption packed column for carbon dioxide-sodium hydroxide system. *Assumption University of Thailand Journal* 2006; 10 (2): 132-140.
- [4] Mores P, Scenna N, Mussati S.. A rate based model of a packed column for co<sub>2</sub> absorption using aqueous monoethanolamine solution. *International Journal of Greenhouse Gas Control* 2012; 6: 21–36.
- [5] Mac Dowell N, Samsatli NJ, Shah N. Dynamic modelling and analysis of an amine-based post-combustion co<sub>2</sub> capture absorption column. *International Journal of Greenhouse Gas Control* 2013; 12: 247–258.
- [6] Asendrych D, Niegodajew P, Drobniak S. CFD Modeling of CO<sub>2</sub> capture in a packed bed by chemical absorption. *The Journal of Committee of Chemical and Process of Polish Academy of Sciences* 2013; 34 (2): 269-282.
- [7] Bedelbayev, Greerand Lie ,”Model Based Control of Absorption Tower for CO<sub>2</sub> Capturing” 12<sup>th</sup> international symposium on process systems engineering and 25<sup>th</sup> European Symosium on computer aided engineering,2008.
- [8] Harun, Douglas, Croiset and Sandoval “Dynamic Simulation and Control of MEA Absorption Process for CO<sub>2</sub> Capure from Power Plants” 6<sup>th</sup> international conference on process systems engineering, Kuala Lumpur,2013.
- [9] Eying E, Da Silva FV, PalúII F, Fileti MFF. Neural network based control of an absorption column in the process of bioethanol production. *Journal of Brazilian Archives of Biology and Technology* 2009; 52 (4): 961-972.
- [10] Chen Bin, Li Xiao-bin, LIU Gui-hua,PENG Zhi-hong, ZHOU Qiu-sheng,XU Xiao-hui, LIU Xiag-min “Investigation on the Rate of Reaction Between Gas (CO<sub>2</sub>)and Liquor (NaOH) Phases”, Greenhouse gases capturing, Utilization and Reduction,chapter 5, PP.978-953,2012.
- [11] Perry’s chemical engineering handbook 7<sup>th</sup> edition, chapter 11.
- [12] Passino and Yurkovich “Fuzzy Control”, book, Addison Wesley Longman Inc, 1998.