

Vertical Forced Vibration Effect on Natural Convective Performance of Longitudinal Fin Heat Sinks

**Abdalhamid Rafea Sarhan, Assistant Lecturer
Mechanical Engineering Department-University of Anbar**

Abstract

This paper reports an experimental study for the effect of forced vertical vibrations on natural convection heat transfer, by the use of longitudinally finned plate made from Aluminum with dimensions (100, 300 and 3 mm) . The sample of test was heated under the condition of a constant heat flux which is generated by applying an alternating voltage on a fixed resistor mounted on the underside of the sample test which was located horizontally or inclined in multiple angles at a range of (30°, 60° and 90°). An experimental set-up was constructed and calibrated, 16 sets of fin-arrays were tested in atmosphere. Fin length, fin thicknesses and fin height were fixed at 300 mm, 3 mm and 13 mm respectively. The base-to-ambient temperature difference was also varied independently and systematically with the power supply to the heater ranging from 250 W/m² to 1500W/m². The frequency was varied at (0, 2, 6, 10 and 16 Hz) and the amplitude wain the range of (1.63-7.16 mm). The relation between the heat transfer coefficient and the amplitude of vibration is directly proportional with the inclination angle from (0°, 30°, 60°). Results show that the heat transfer coefficients of the heated plate in (30°) angle are about (19.27%) greater than those for the (60°) and exceeds that of the (90°) by (31.4%).

Keywords: Natural Convection, Forced vibration, Longitudinal fins.

تأثير الاهتزازات القسرية الشاقولية في الحمل الحر من صفيحة ذات زعانف طولية

الخلاصة

يتضمن البحث دراسة عملية لبيان تأثير الاهتزازات القسرية الشاقولية في معامل انتقال الحرارة بالحمل الحر من صفيحة ذات زعانف طولية مصنعة من مادة الألمنيوم، ومقارنة النتائج مع صفيحة مستوية. سخنت الصفيحة بفيض حراري نحو الأعلى ثابت يتراوح بين (250 – 1500 W/m²)، ولزوايا ميل تراوحت بين (90°، 60°، 30°). نموذج الاختبار يحتوي (16) صف من الزعانف، أبعاد كل زعنفة (300 mm) طول، (13 mm) ارتفاع، و (3mm) سمك. تمت دراسة تأثير كل من التردد (f) لمدى (2, 6, 10, 16 Hz)، وسعة اهتزاز (a) التي تراوحت بين (1.63 – 7.16 mm). بينت النتائج أن العلاقة بين معدل انتقال الحرارة بالحمل الحر وسعة الاهتزاز هي علاقة طردية للزوايا (90°، 60°، 30°). كما تبين أن معامل انتقال الحرارة بالحمل الحر يقل بزيادة الزاوية عن الأفق، حيث كانت قيمته عند الزاوية (30°) أكبر بنسبة (19.27%) منه عند الزاوية (60°)، وأعلى بنسبة (31.4%) من الزاوية (90°).

الكلمات الدالة: الحمل الحر ، الاهتزازات القسرية ، زعانف طولية.

Nomenclatures

T_f	film temperature, ($^{\circ}\text{C}$)
T_{∞}	ambient temperature, ($^{\circ}\text{C}$)
T_s	base temperature, ($^{\circ}\text{C}$)
Q_t	heat generation, (W)
Q_C	convection heat transfer from base by fin, (W)
Q_R	radiation heat transfer from single fin, (W)
Q_{fin}	heat transfer from single fin, (W)
Q_s	Heat transfer from base unoccupied by fin, (W)
n	number of fins
η_{fin}	efficiency
h	heat transfer coefficient, ($\text{W}/\text{m}^2 \cdot ^{\circ}\text{C}$)
A_{fin}	cross-sectional area of fin, (m^2)
A_s	base area not occupied by fin, (m^2)
δ	characteristic length, (m)
k	thermal conductivity, ($\text{W}/\text{m} \cdot ^{\circ}\text{C}$)
k_f	fluid thermal conductivity, ($\text{W}/\text{m} \cdot ^{\circ}\text{C}$)
f	frequency, (Hz)
a	amplitude of vibration, (m)
β	thermal expansion coefficient, (K^{-1})
g	gravity acceleration, (m/s^2)
$acc.$	Acceleration of vibration, (m)
Nu	Nusselt number
Ra	Rayleigh number
Ra_v	vibration Reynolds number
u_v	Vibration speed, (m/s)
t	Thickness of plate, (mm)
L	length of plate, (mm)
W	width of plate, (mm)

Introduction

Natural convection heat transfer from finned surfaces has been the subject of a large Number of experimental and theoretical investigations. Extended

surface or fins are used to increase the heat dissipation in many engineering and industrial applications by increasing the heat transfer area. They are used in cooling of electronic and thermo electronic devices solar energy applications, cooling of nuclear reactor fuel elements, improving heat transfer in radiators for air conditioning and in air cooled heat exchangers. In most of devices air is the heat transfer medium. At the air side of any heat exchanger, fins are used with different types.

The type of fins used depends on manufacturing process and the space available in heat generated devices to be involved in cooling process. Natural convection from heat sinks has long been utilized for the thermal management of low-power-density devices. With the features of high system reliability, free of maintenance, and zero power consumption, this cooling technique plays an important role in the electronic cooling industry and has attracted considerable researches for decades. Most research on the free convection heat transfer from finned and other parts did not address that these parts may be exposed to vibrations due to the nature of work ^[1].

Abdalhamid R. S. ^[2] performs an experimental study for the effect of forced vertical vibrations on free convection heat transfer coefficient, from flat plate made of aluminum with dimension (300 mm length, 100 mm width, and 3 mm thickness). It has been heated under a constant heat flux of ($250\text{-}1500 \text{ W}/\text{m}^2$) in upward direction. The flat plate was located horizontally or inclined in multiple angles at range of (0° , 30° , 45° ,

60°, 90°). The experimental study is carried out at a range of frequency (2-16 Hz) and the amplitude at the range of (1.63-7.16 mm). The results of this study show that the relation between the heat transfer coefficient and the amplitude of vibration is incrementally for inclination angles from (0°, 30°, 45°, 60°), and reaches a maximum ratio of (13.3%) in the horizontal state, except at the vertical state ($\theta = 90^\circ$) the heat transfer coefficient decreases as the excitation increases and the maximum decrease ratio occurs at (7.65 %).

An experiment study was carried out on natural convection heat transfer from longitudinal trapezoidal fins array heat sink subjected to influence of orientation by Saad M. J. Al-Azawi ^[1]. Test results indicate that the sideward horizontal fin orientation yield the lowest heat transfer coefficient. From the results; heat transfer coefficient of the side ward vertical fins is higher by (12%) than the heat transfer coefficient of the upward while it is higher than the heat transfer coefficient of the downward by (26%) and by (120%) with the sideward horizontal fins.

H. Yuncu, G. Anbar ^[3] this study reports an experimental study of free convection heat transfer from rectangular fin-arrays on a horizontal base. An experimental set-up was constructed and calibrated, 15 sets of fin-arrays and a base plate without fins were tested in atmosphere. Fin height was varied from 6 mm to 26 mm. Fin spacing was varied from 6.2 mm to 83 mm. The base-to-ambient temperature difference was also varied independently and systematically with the power supply to heater ranging from

8 W to 50 W. Fin length and fin thicknesses were fixed at 100 mm and 3 mm, respectively. The experimental program was conducted so as to clearly delineate the separate roles of fin height, fin spacing and base-to-ambient temperature difference. It was found that for a given base-to-ambient temperature difference the convection heat transfer rate from fin-arrays takes on a maximum value as a function of fin spacing and fin height.

Sparrow and Vemuri ^[4] studied the fin orientation on natural convection/radiation heat transfer from pin fin arrays. Their results revealed that the upward facing orientation yielded the highest heat transfer rates, followed by the sideward facing and the downward facing ones.

Experimental Set-up Procedure

The experimental facility developed for the investigation is shown in Fig. (1). Experiments are carried out on natural convection heat transfer from longitudinal fins array heat sink placed in different orientation (30°, 60°, 90°) by tilting mechanism. The tilting mechanism is designed to allow for the heat sink to move in angular motion from (0° to 360°). The holder is U-shaped and made from iron substance to alleviate the weight exerted on vibrator. The holder base is also iron-made to avoid holder deformation due to vibration and to transfer the oscillatory motion in efficient way. The longitudinal fins array heat sink is fixed with connection arms using Teflon substance to reduce the heating loss at its ends. The base plate of the heat sink has the

dimensions of (100 × 300 × 3 mm). Fig. (2) shows the dimensions of the fin array heat skin. The base plate is equipped with an electrical heating element with thermostatic protection against overheating was placed at the downward face of plate between two mica sheets providing electrical insulation.

The base plate temperature is measured by a thirty thermocouples (type K) placed at symmetric location in the downward face of plate as shown in Fig. (3).

Calculation Procedure

In the present study, the ambient temperature ranging from 28 to 31 °C, and thermo physical properties in Nusselt and Rayleigh number are evaluated at the film temperature (T_f) [5],

$$T_f = \frac{1}{2} (T_\infty + T_s) \quad \dots (1)$$

If the base temperature of the heat sinks T_s is the average temperature of the thirty thermocouples that placed in the downward face plate, and neglecting conduction downward losses then the energy balance for the heat sink is

$$Q_t = Q_c + Q_r \quad \dots (2)$$

where, Q_t represents the power input to the heater, which it can be calculated from the following,

$$Q_t = I V \quad \dots (3)$$

The heat transfer coefficient can be evaluated from the following,

$$Q_c = n Q_{fin} + Q_s \quad \dots (4)$$

Where,

$$Q_{fin} = A_{fin} \eta_{fin} h (T_s - T_\infty) \quad \dots (5a)$$

$$Q_s = A_s h (T_s - T_\infty) \quad \dots (5b)$$

The total heat transfer surface consisting from surface fins area ($A_{fin} = 0.1392 \text{ m}^2$) and the base plate without fin area ($A_s = 0.0156 \text{ m}^2$), therefore, ($A_t = 0.1548 \text{ m}^2$). By substitution equations (5a & 5b) in equation (4), the convection heat transfer coefficient can be expressed as,

$$h = \frac{Q_c}{(0.1392 \eta_{fin} + 0.0156)(T_s - T_\infty)} \quad \dots (6)$$

where (η_{fin}) is fin efficiency, which defined as

$$\eta_{fin} = \frac{\tanh(mH)}{mH} \quad \dots (7)$$

Where,

$$m = \sqrt{hp/KA} \quad \dots (8)$$

The dimensionless variables such as Nusselt number (Nu), Rayleigh number (Ra), vibration Reynolds number (Re_v), vibration speed (u_v) and amplitude of vibration can be defined as,

$$Nu = h \delta / k_f \quad \dots (9a)$$

$$Ra = \frac{g \beta (T_s - T_\infty) \delta^3}{\alpha \nu} \quad \dots (9b)$$

$$Re_v = \frac{2\pi f a \delta}{\nu} \quad \dots (9c)$$

$$u_v = a \times f \quad \dots (9d)$$

$$a = \frac{acc.}{(2\pi f)^2 \times \sqrt{2}} \quad \dots (9e)$$

The volumetric expansion coefficient is calculated based on the following equation,

$$\beta = 1/(T_f + 273) \quad \dots (10)$$

The present study include calculating the dimensionless numbers like Nusselt number (Nu), Rayleigh number (Ra) and vibratory Reynolds number (Re_v). The study has strongly relied on dimensional numerical analysis to find equations relate such numbers to each other.

$$Nu = N_1 Ra^{N_2} \theta^{N_3} Re_v^{N_4} \quad \dots (11)$$

Results and discussion

Figures (4, 5 and 6) describe the relationship between Nusselt number and Rayleigh number for different inclination angles for the model-based testing in the research, compared with flat plate Reference [2]. The figures show that the number of Nusselt increases in direction with the increase in the number of Rayleigh, but this increase is the largest as possible at the angle (30°) than the angle (60°) than the angle (90°) due to the forces of buoyancy have an effective impact at the angle near horizontal, in addition to that the presence of fins in the form of the test adopted in this research leads to increased surface area and thereby increase the heat transfer, in addition to this that increase the tendency for model test runs on heating fins themselves and so are the fins as a source of currents to carry, but for the angle (90°) working each fin on heating other

fin (that topped) and therefore be increasing heat transfer.

Figures (7, 8, 9 and 10) describe the relationship between Nusselt number and Reynolds vibrating number for different inclination angles adopted in the research. From the figures it can be seen that the Nusselt number increases with increasing vibrating Reynolds number which mean that the effect of forced frequency working on increase the heat transfer

Figures (11, 12 and 13) indicate that the Nusselt number increases with increasing frequency for different values of the different heat flux, and the increasing is proportional, but it is simple and for different inclination angles

Figures (14, 15 and 16) indicate that the amount of forced frequency working to increase the heat transfer coefficient which mean it works to break the thermal boundary layer of the tested model as well as to increase the surface area proved to be more effective than model without fin.

Figure (17) shows fins establish paths with a large surface area and in turn lead to increased heat exchange, the dimension of the influential is ($L \cos \theta$) in addition to the forces of buoyancy is working to increase the heat exchange, increase thermal eddies lead to heating the fins which will decrease the effectiveness of the fins. As for the angle (90°) to the fact that the distances are close, the vibration movement heats the fins themselves and thus the form become a heat source integrated with a wide surface area and thus have a greater amount of heat transmitted.

Empirical Deduced Relationships

Based on experimental results, an empirical equation which relates Nusselt number, vibratory Reynolds number, Rayleigh number and angular position has been obtained. Table (1) shows the values of the constants (N_1 , N_2 , N_3 and N_4) those appear in equation (11) for all angle depended in the search.

Conclusions

Based on experimental observations and results, the following points can be highlighted:

1. The effect of Fins lead to increase heat transfer rate, and the highest value of this increase at the angle (30°) proportional without vibration, this is the result that the presence of fins working to increase the surface area of the heat exchanger and thereby increase the amount of heat transmitted.
2. The heat transfer coefficient decrease with to increasing the angle of the horizontal and reach its highest value ($344.4 \text{ w/m}^2 \cdot ^\circ\text{C}$) when the angle 30° , this due to the buoyancy force have the biggest impact in the process of free convection heat transfer.
3. The small amplitude of vibration has a limited effect on surface contiguous layer. However, to improve the heat transfer coefficient, high vibration amplitude is required to penetrate such contiguous layer.
4. Increase the Rayleigh number lead to increased vibration Nusselt number for different angles adopted in the research.

5. The Reynolds number (Re_v) increases with increased value of vibration intensity and for different angular positions. The level of such increase is much enhanced with increasing angular position.

References

1. Saad M. Al-Azawi, "Effect Orientation on performance of Longitudinal (Trapezoidal) Fins Heat Sink Subjected to Natural Convection" AJES-2009, Vol. 2, No.2.
2. Abdalhamid R. S., "Experimental study of the effect of vertical forced vibrations on natural convection heat transfer coefficient from flat plate heated upward", University of Technology, Bagdad, 2009.
3. H. Yuncu, Anbar, "An experimental investigation on performance of rectangular fins on a horizontal base in free convection heat transfer", Heat and Mass Transfer, 33 (1998), 507-514.
4. E. M. Sparrow, S. B. Vemuri, "Orientation on natural convection/radiation heat transfer from pin fin array", Int. J. Heat and Mass Transfer, 29 (1989), 359-368.
5. K. L. Kumar, "Engineering Fluid Mechanics", 5th Edition, Boston, 1990.

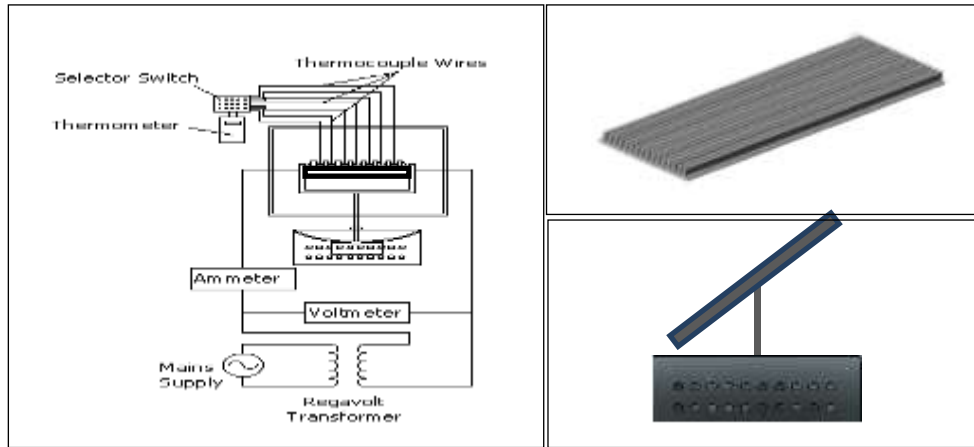

Figure (1). Experimental rig.

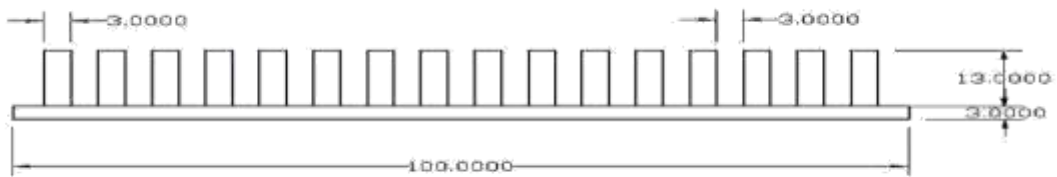

Figure. (2). Dimensions of the fin array heat skin

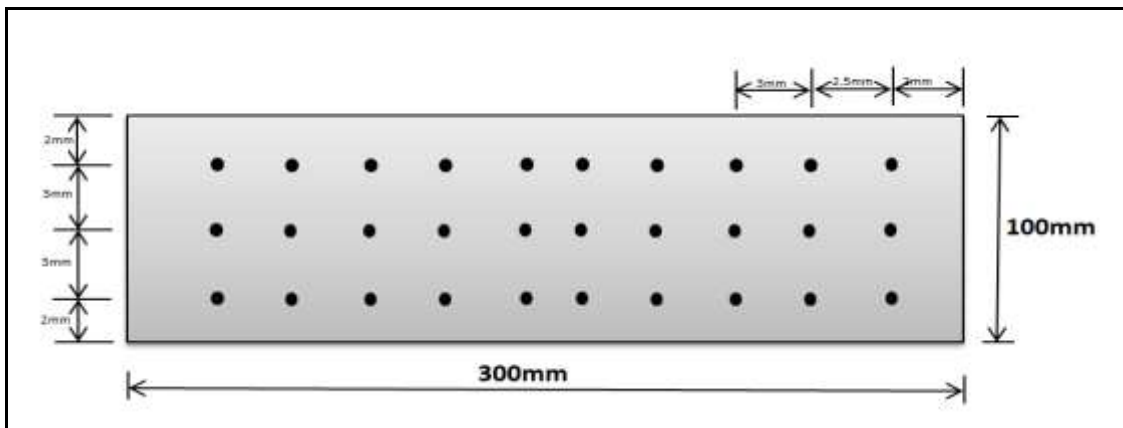

Figure. (3). Thirty thermocouples (type K) placed in the downward face of the plate

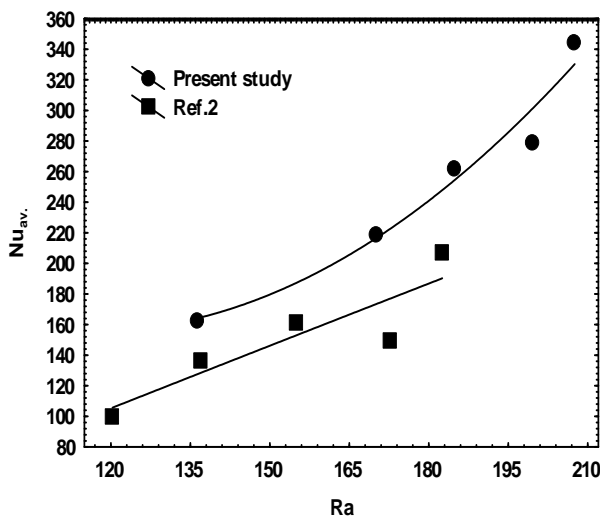

Figure.(5) The relation between $Nu_{av.}$ & Ra at

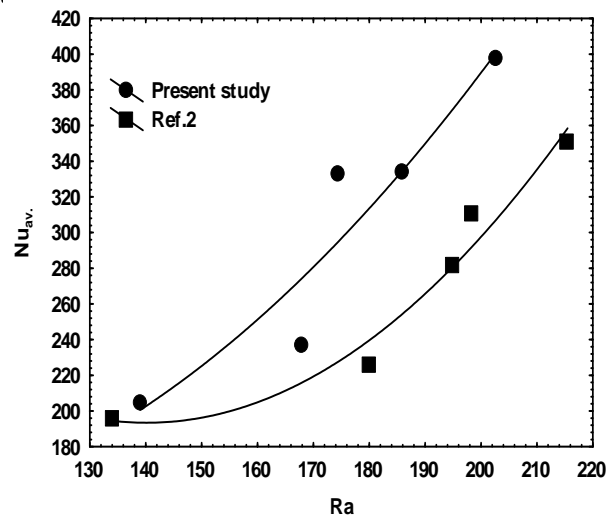

Figure.(4) The relation between $Nu_{av.}$ & Ra at

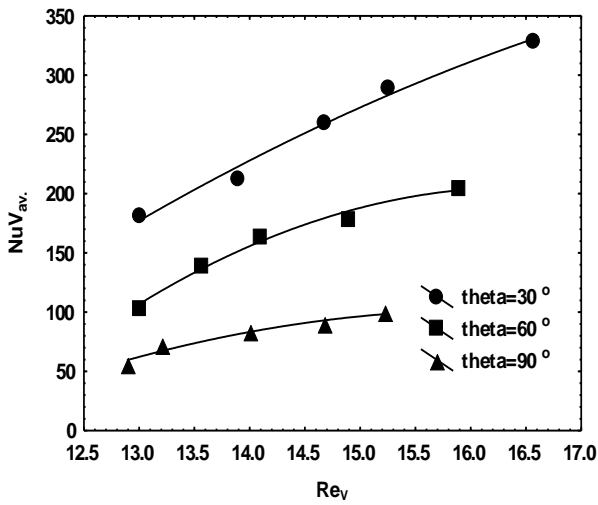

Figure.(7) The relation between Nu_{v,av} & Re_v at

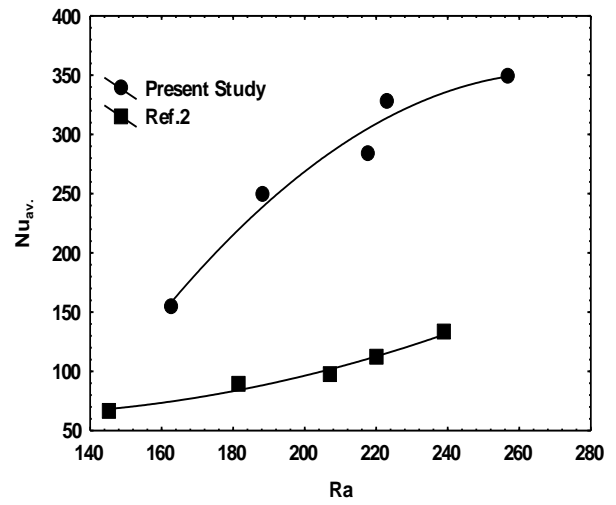

Figure.(6) The relation between Nu_{av} & Ra at

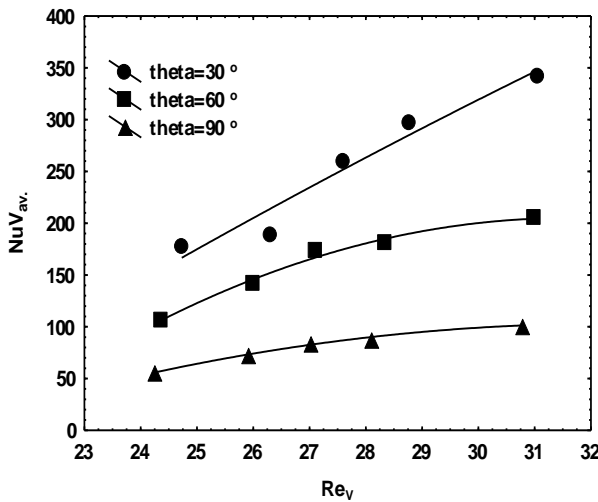

Figure.(9) The relation between Nu_{v,av} & Re_v at

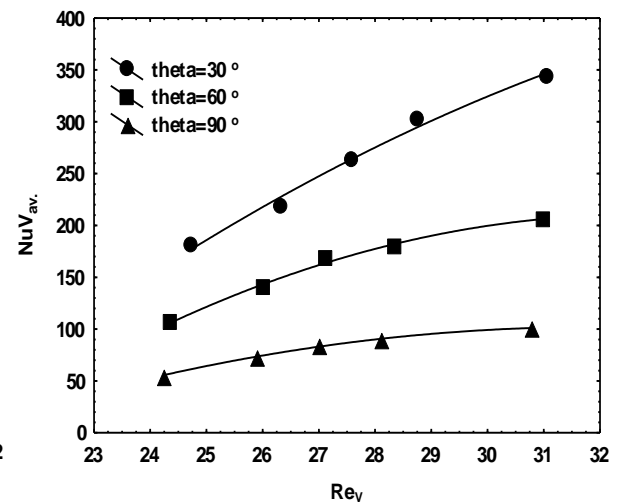

Figure.(8) The relation between Nu_{v,av} & Re_v at

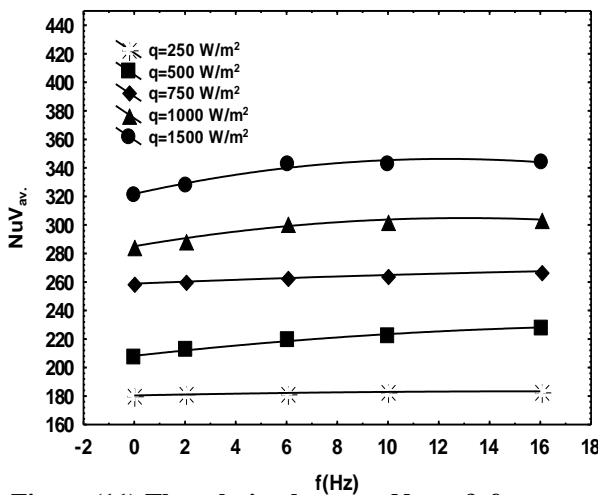

Figure.(11) The relation between Nu_{v,av} & frequency at $\theta=30^\circ$

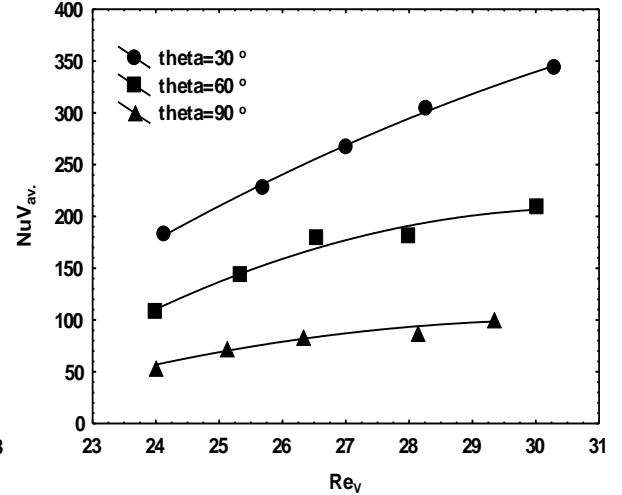

Figure.(10) The relation between Nu_{v,av} & Re_v at f=16

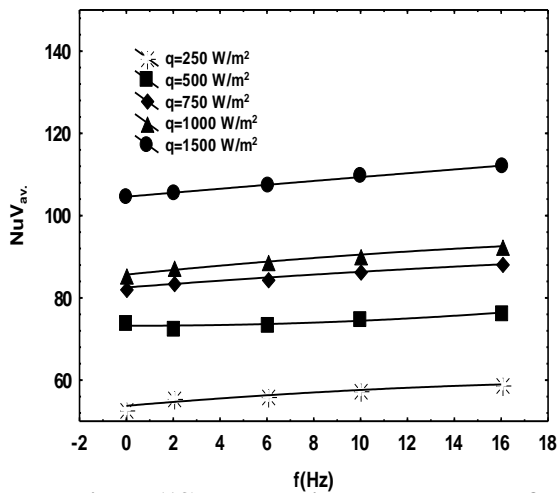

Figure.(13) The relation between $Nu_{v,av}$ & frequency at $\theta=90^\circ$

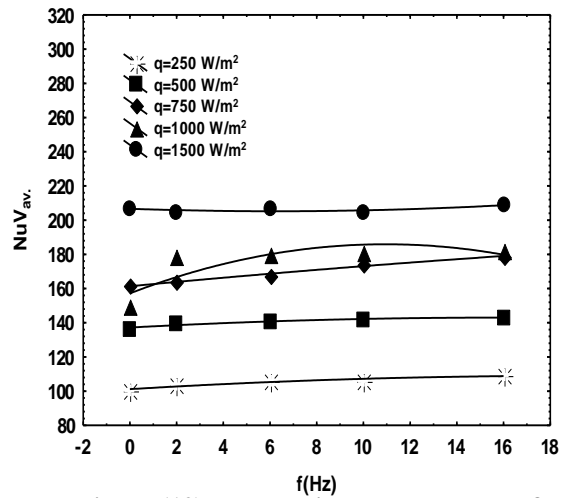

Figure.(12) The relation between $Nu_{v,av}$ & frequency

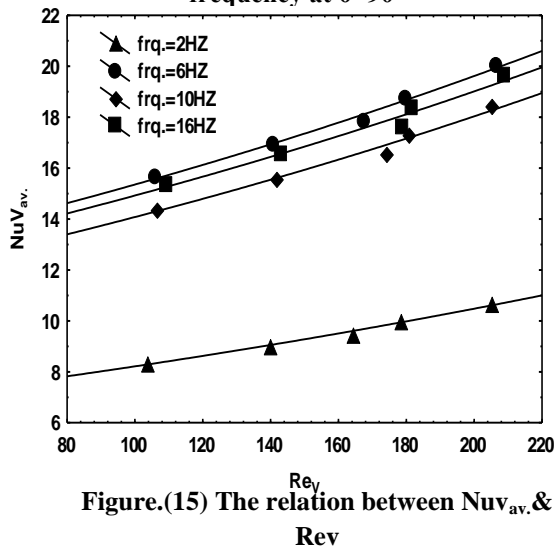

Figure.(15) The relation between $Nu_{v,av}$ & Re_v at $\theta=90^\circ$

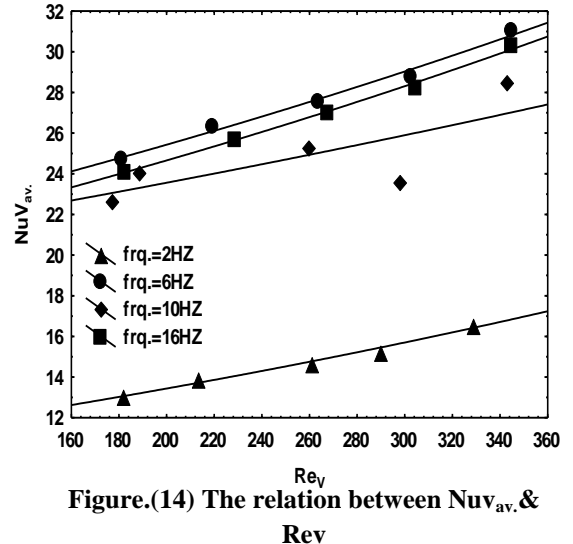
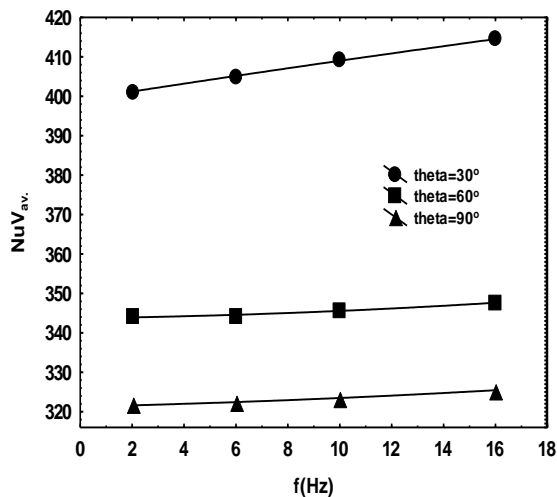

Figure.(14) The relation between $Nu_{v,av}$ & Re_v



Figure(17) The relation between $Nu_{v,av}$ & frequency

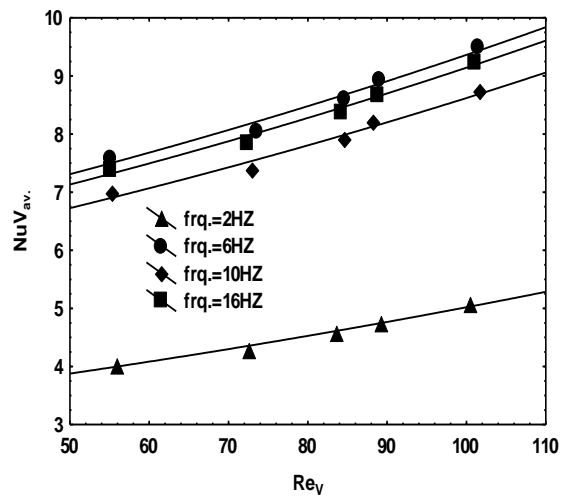

Figure.(16) The relation between $Nu_{v,av}$ & Re_v at $\theta=90^\circ$

Table (1). The values of the constants (N_1 , N_2 , N_3 and N_4)

<i>Freq.</i>	<i>Angle</i>	N_1	N_2	N_3	N_4
2 Hz	30°	1.27×10^{-6}	3.002	1.36	2.124
	60°	1.04×10^{-6}	0.9206	1.488	1.563
	90°	6.317×10^{-7}	2.676	2.076	1.897
6 Hz	30°	7.93×10^{-9}	3.346	2.089	2.561
	60°	8.36×10^{-6}	0.845	1.721	0.922
	90°	4.809×10^{-8}	2.76	2.328	2.112
10 Hz	30°	6×10^{-11}	3.724	3.035	2.873
	60°	27.81	1.079	-1.068	0.638
	90°	4.354×10^{-17}	5.057	5.031	5.321
16 Hz	30°	1.82×10^{-10}	3.554	2.924	3.631
	60°	6.786	1.34	-1.032	-1.033
	90°	3.787×10^{-4}	1.859	1.065	1.779